



锐图

激光加工头——切割系列

Smart xBeam Delivery——BeamCut

 上海嘉强自动化技术有限公司
Shanghai Empower Technologies Co., Ltd.

上海总部

地址：上海市松江区东宝路8号
咨询热线：400-670-1510
邮箱：sales@empower.cn
网址：www.empower.cn

深圳

深圳嘉强激光技术有限公司
地址：广东省深圳市宝安区新桥街道新玉路84号B栋105
电话：0755-26903927

苏州

苏州嘉强自动化技术有限公司
地址：江苏省苏州市常熟市尚湖镇翁庄路16号
电话：13917215193

武汉

武汉嘉强智能技术有限公司
地址：湖北省武汉市洪山区光谷创业街73号E3116
电话：027-81302226

济南

地址：山东省济南市高新区春晖路2966号智造谷产业园18号楼3楼
电话：15800670766

@202307



A 数控系统

B 激光传导

C 工业物联

上海嘉强自动化技术有限公司

赋能激光智造 · 综合解决方案



上海嘉强智能工厂基地

Empower嘉强成立于2009年,是激光制造行业的高新技术企业。专注于“xEOS赋能激光智造ABC”——提供基于Ahead-Techs开放数控、BeamTools智能激光头、CloudAhead云端服务的RayTools锐图品牌ABC方案平台。

我们的锐图ABC方案以“锐意进取创新图强”为宗旨,“让激光有智慧,让智造有灵魂,让应用有个性”为愿景,提供专业的一站式智能激光应用开放型xAPP解决方案,包括激光切割、打孔、焊接、熔覆、淬火、表面处理、微加工等制造业基础工具套件。嘉强的公司使命是致力于打造激光中央厨房和OEM渠道嘉强合作开放分布式总线创新型方案,促进激光装备生产力,将激光应用融合进下游的千行百业,为智能激光制造服务并与集成商和渠道共赢共创价值。

Founded in 2009, Shanghai Empower Technologies Co.,Ltd. is a high-tech enterprise in the laser manufacturing industry. Since its inception, Empower strives for "xEOS Empower Laser Smart ABC", providing RayTools ABC solutions based on AheadTechs CNC, BeamTools smart laser head, and CloudAhead cloud services.

We set the aim of RayTools ABC solutions as "advance with innovation and strength" and the vision as "Creating Unique Smart Laser & Automation". Starting with the two concepts, we provide professionally one-stop xAPP solutions for intelligent laser applications, covering laser cutting, drilling, welding, cladding, hardening, surface treatment, micro-processing, and other basic tools for manufacturing.

We attempt to build an open laser system and overall innovative solutions featuring OEM Empower open cooperation & distribution mode. By doing so, we act to promote the productivity of laser equipment and the integration of laser applications into the downstream industries, further creating value for intelligent laser manufacturing and win-win cooperation with integrators and developing channels.

使命 Mission

打造激光中央厨房,创新综合解决方案
促进智能装备生产力,为激光服务共创价值
Empower Openlaser Systems

愿景 Vision

让激光有智慧 让智造有灵魂 让应用有个性
Open-Minded Machinery and Automations

价值观 Value

嘉言善行 庄敬自强
Doing Good Deeds

赋能激光智造

Empower Openlaser Systems

xMotion

数控系统



xLaser

激光传导



xConnect

工业物联



我们的产品可以做什么

三维切割3D Cutting



平面切割Flat Cutting

熔覆Cladding

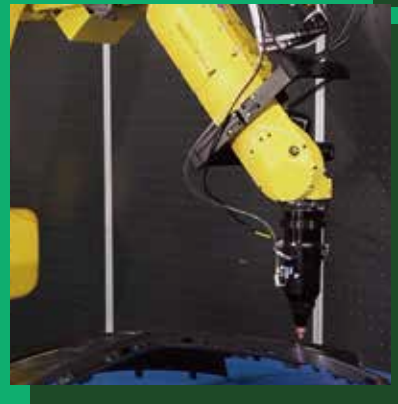

三维非金属切割3D Non-metal Cutting

焊接Welding



精密切割Micro Cutting



WHAT
WE
DO

全球网络 Global Network



产品业务完整 A Board Range of Products and Turnkey Solutions

从激光加工头、配件、定制模块，到整体激光综合加工方案，我们提供5000多种产品，可满足各种工业激光应用需求。

We offer more than 5000 SKU off the shelf, including laser processing heads, accessories, customized modules and turnkey solutions to meet needs of various industrial laser applications.

客户规模大 Large Scale Customer Base

拥有近2000多家客户，其中国内覆盖全国30个省市，国际拥有美洲、欧洲、亚洲等100多家客户。

With more than 2000 clients, among which there are more than 100 overseas clients, our customer base covers 30 domestic provinces and international markets like America, Europe, and Asia.

开放技术平台 Open Platform and Sustainable Innovation

借助我们的开放式x CNC软件和x Beam Delivery模块平台，我们可以为您的特定应用场景定制激光头产品、嵌入式软件或解决方案套件。

我们获得了超过100项专利和版权，并且还有更多项目正在进行中，我们的团队从未停止创新。

With our open platform of x CNC software and x Beam Delivery modules, laser processing heads, the embedded software and solution kits can be customized to clients' needs based on specific applications. With over 100 patents and copyrights and more projects in progress, our innovation never stops.

服务响应快 Fast Response Service

拥有深圳、苏州、武汉、济南办事处，我们秉持“12小时响应、48小时上门”的服务宗旨，全心全意为客户提供优质的一站式服务。

With offices in the cities of Shenzhen, Suzhou, Wuhan and Jinan, we adhere to the purpose of "12-hour response, 48-hours door-to-door" service and wholeheartedly provide our customers with quality one-stop service.

服务热线：
Hotline **400-670-1510**

服务邮箱：
Service Email **service@empower.cn**

ShangHai

上海总部

地址：上海市松江区东宝路8号

邮箱：sales@empower.cn

网址：www.empower.cn

热线：400-670-1510

转1号键售前产品订购咨询

转2号键售后上门维修咨询

转3号键产品返厂维修咨询

传真：(021) 6760-1511

ShenZhen 深圳

座机：(0755) 2690-3927

地址：广东省深圳市宝安区新桥街道新玉路84号

B栋105、205

Suzhou 苏州

地址：江苏省苏州市常熟市尚湖镇翁庄路16号

WuHan 武汉

座机：(027) 8130-2226

地址：湖北省武汉市东湖洪山区光谷创业街73号

E3116

JiNan 济南

地址：山东省济南市高新区春晖路2966号

智造谷产业园18号楼301-306

USA 美国

座机：1-781-995-7305

地址：10 Wedge Pond Road, Winchester, MA 01890

USA

Switzerland 瑞士

座机：+41-788274963

地址：Emmentalstrasse 96, CH-3414 Oberburg,

Switzerland

目录

CONTENT

/ BT手动系列

BeamTool Series

- 01 **BT210S** 中低功率切割头 1.5kW
Medium and Low Power Cutting Head
- 02 **BT220** 中低功率切割头 2kW
Medium and Low Power Cutting Head
- 03 **BT240S** 中低功率切割头 3.3kW
Medium and Low Power Cutting Head
- 07 **FM220** 精细切割头 0.5kW/1.5kW
Micro Cutting Head

/ BM自动系列

BeamMotion Series

- 09 **BM110** 高性能自动调焦切割头 3.3kW
High-performance Auto Focus Cutting Head
- 11 **BM111** 高性能自动调焦切割头 3.3kW
High-performance Auto Focus Cutting Head
- 13 **BM04K** 高性能自动调焦切割头——ECAT版 4kW
High-performance EtherCAT Auto Focus Cutting Head
- 15 **BM06K** 高性能自动调焦切割头 6kW
High-performance Auto Focus Cutting Head
- 17 **BM06K-3D** 高性能自动调焦切割头 6kW
High-performance Auto Focus Cutting Head
- 19 **BM06K-3D-90°** 高性能自动调焦切割头 6kW
High-performance Auto Focus Cutting Head

/ BS智能系列

BeamSmart Series

- 21 **BS06K** 高功率智能切割头 6kW/8kW
High Power Smart Cutting Head
- 23 **BS06K** 高功率智能切割头——ECAT版 6kW/8kW
High Power EtherCAT Smart Cutting Head

- 25 **BS12K** 高功率智能切割头 12kW
High Power Smart Cutting Head
- 27 **BS12K-3D** 高功率智能切割头 12kW
High Power Smart Cutting Head
- 29 **BS20K** 高功率智能切割头 20kW
High Power EtherCAT Smart Cutting Head
- 31 **BS30K** 高功率智能切割头 30kW
High Power Smart Cutting Head

/ 三维系列

BeamBlade Series

- 33 **BD04K** 三维管切切割头 4kW
3D Pipe Cutting Head

/ GF多轴系列

GF Series

- 35 **GF101** 3D机器人手动调焦切割头 4kW
Manual Focus 3D Robot Cutting Head
- 36 **GF101F** 3D机器人自动调焦切割头 4kW
Auto Focus 3D Robot Cutting Head
- 37 **GF102** 机器人用小轮廓插补子系统 根据激光头功率
Small Contour Interpolation Subsystem for Robot
- 39 **GF402** 四轴管材坡口切割头 6kW
Four-Axis Tube Bevel Cutting Head
- 41 **GF403** 单摆直角输出激光头 根据激光头功率
Orthogonal Output Uniaxial Wobble Laser Head
- 43 **GF501** 五轴三维激光切割头 3kW
Five-Axis 3D Laser Cutting Head
- 45 **GF502** 龙门AB轴摆动坡口子系统 根据激光头功率
Gantry AB Axis Wobble Groove Subsystem

/ 解决方案

Laser Solutions Kits

- 47 **LaserRobot** 非金属三维切割解决方案
3D Non-metal Cutting Solutions
- 49 **DynaTools** 直线电机切割解决方案
Linear Motor based Cutting Solutions
- 51 **导光臂**
Light Guiding Arm

/ 配件辅件

Accessories

- 52 **穿孔检测**
Pierce Detector

BT210S

中低功率切割头

Medium and Low Power Cutting Head

功率等级 1.5kW
Power Rating



更多信息请扫描二维码
Scan to get details

高性价比

Highly Cost-effective

1500W及以下功率的经济型激光切割设备的首选

The best choice for economical laser cutting machine of 1500W power rating and below.

高适配性

High Adaptability

具备QBH和QCS等多款光纤接口，可与各种主流激光器进行适配

Various fiber interfaces like QBH and QCS to work with different prevailing lasers.



*产品图片仅供参考
* For Reference Only

设计优异

Excellent Design

优化的光学配置和平滑高效的气流设计，显著提高切割质量及效率

Optimized optical configuration and smooth gas circuit to improve cutting quality and efficiency significantly.

结构精巧

Ingenious Structure

重量轻，体积小，降低了机床负载要求，提高了切割速度及质量

Light-duty and compact size to decrease the payload of machine tool and improve the cutting speed and quality.

技术参数 Technical Data

功率等级 Power Rating	1500W
通光孔径 Clear Aperture	21mm
辅助气体气压 Assist Gas Pressure	≤20bar
重量 Weight	~ 2.5kg

喷嘴孔口径 Diameter of Nozzle Tip	1.2mm, 1.5mm, 2.0mm, 2.5mm
------------------------------	----------------------------

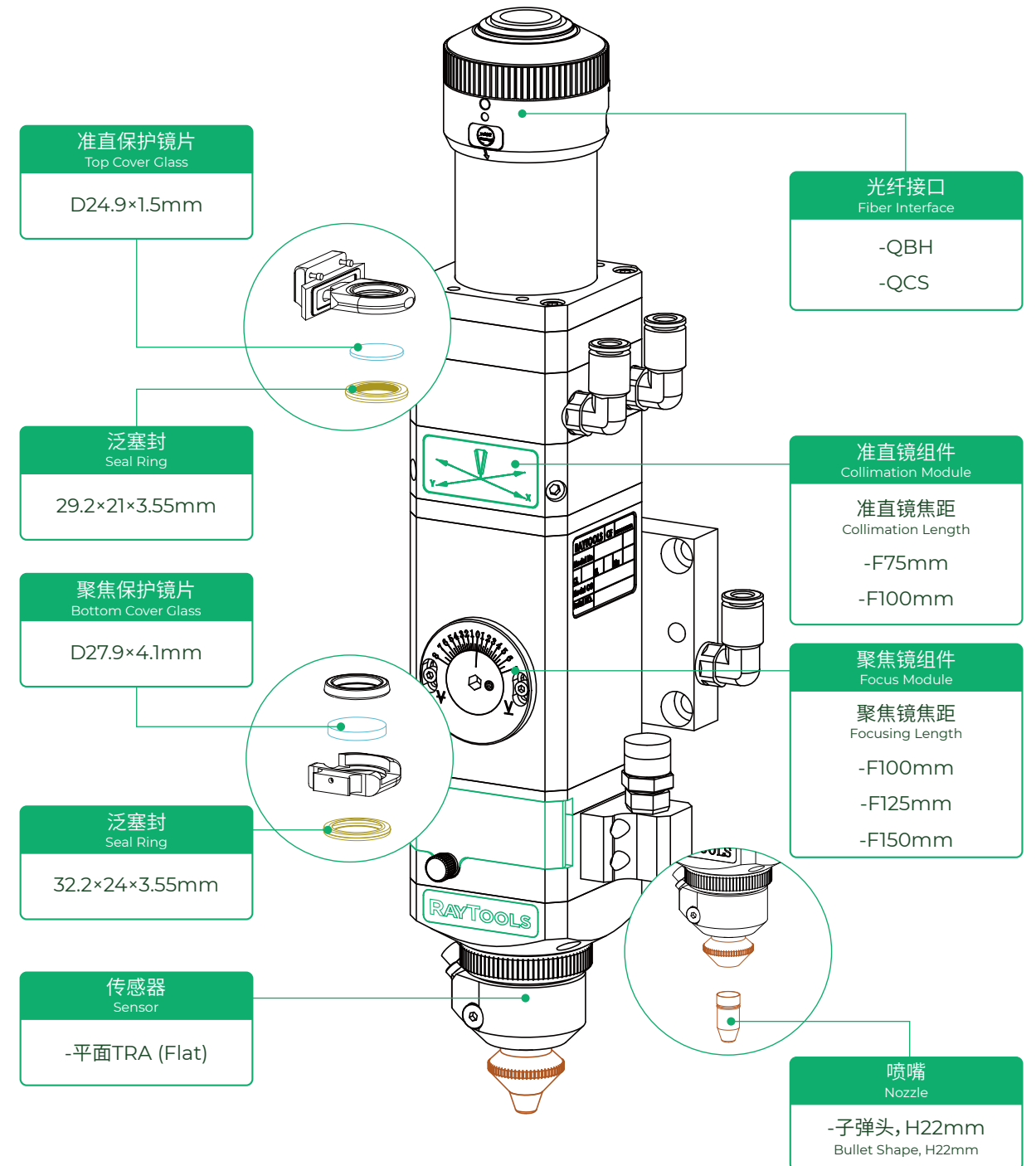

BT220

中低功率切割头

Medium and Low Power Cutting Head

功率等级 **2kW**
Power Rating



更多信息请扫描二维码
Scan to get details

高性价比

Highly Cost-effective

2000W及以下功率的经济型激光切割设备的首选

The best choice for economical laser cutting machine of 2000W power rating and below.



*产品图片仅供参考
* For Reference Only

设计优异

Excellent Design

优化的光学配置和平滑高效的气流设计, 显著提高切割质量及效率
Optimized optical configuration and smooth gas circuit to improve cutting quality and efficiency significantly.

结构精巧

Ingenious Structure

重量轻, 体积小, 降低了机床负载要求, 提高了切割速度及质量
Light-duty and compact size to decrease the payload of machine tool and improve the cutting speed and quality.

技术参数 Technical Data

功率等级 Power Rating	2000W
通光孔径 Clear Aperture	25mm
喷嘴规格 Nozzle Styles	单层, 双层, 非标 Single, Double, Custom

喷嘴孔口径 Diameter of Nozzle Tip	0.8mm, 1.0mm, 1.2mm, 1.5mm, 2.0mm, 2.5mm, 3.0mm, 3.5mm, 4.0mm, 4.5mm, 5.0mm
辅助气体气压 Assist Gas Pressure	≤25bar
重量 Weight	~ 2.6kg

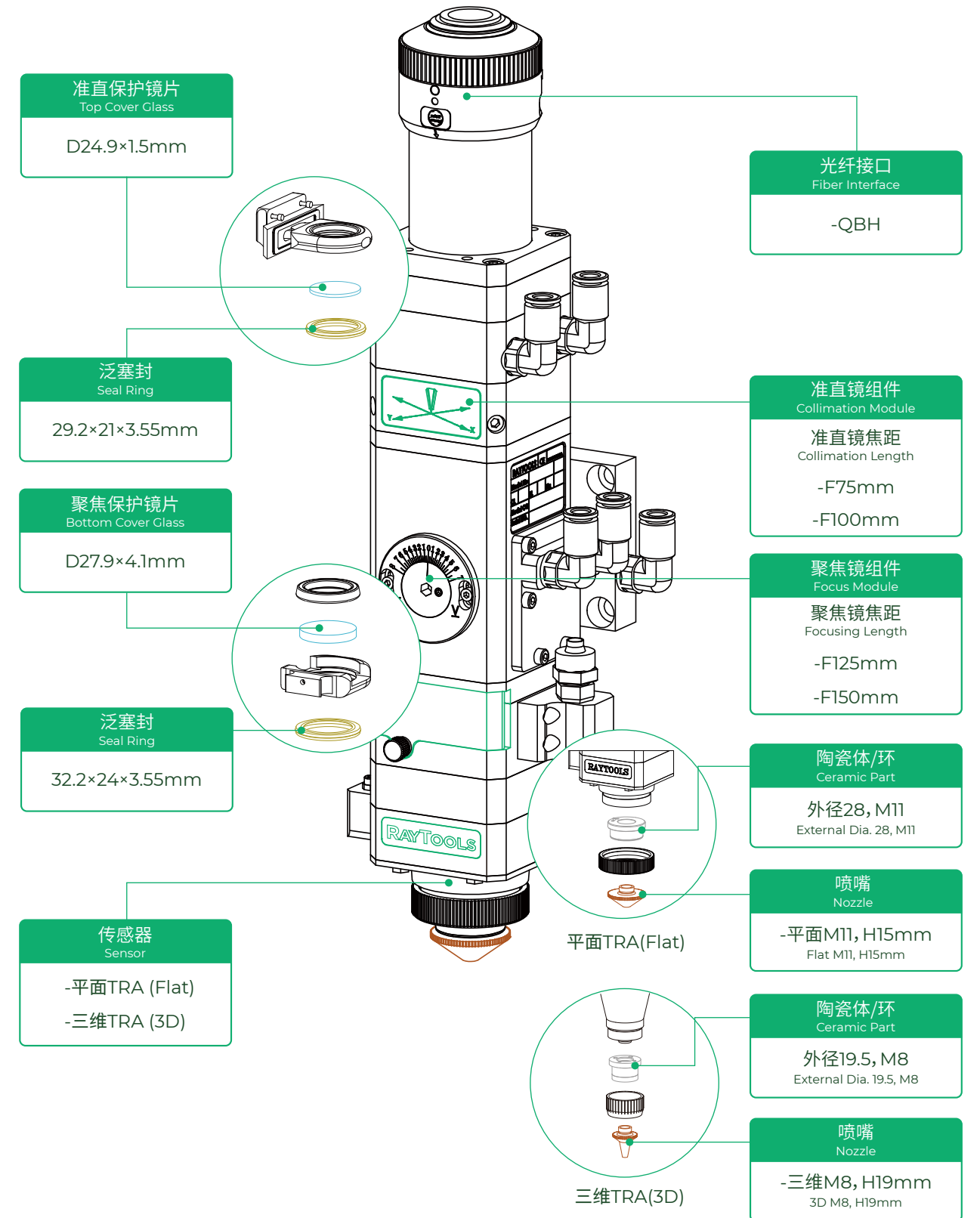

BT240S

中低功率切割头

Medium and Low Power Cutting Head

功率等级 **3.3kW**
Power Rating

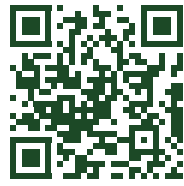

更多信息请扫描二维码
Scan to get details

高度防尘

Excellent Dustproof

防尘等级IP65, 全封闭式包裹光路, 镜片污染可能性几乎为零

IP65 dustproof level with fully enclosed beam path to decrease contamination risk.

动态零焦

Adjustable Zero Focus

可灵活调节焦点刻度, 使零焦位置统一化, 不再为调整工艺参数烦恼

Zero focus scale recovery function to maintain accurate focus adjustment, no worry about the parameter adjustment.



*产品图片仅供参考
* For Reference Only

高效水冷

Efficient Water Cooling

聚焦镜、准直镜、喷嘴均内置冷却功能, 强势解决切割发热问题

Built-in cooling function of collimation, focus modules and nozzle assembly to solve the overheating problem.

优化结构设计

Optimized Structural Design

一体化机身设计, 改进的QBH光纤接口不再因漏水生锈等原因卡死

All-in-one design and improved QBH fiber interface to prevent from being stuck for water leakage and rusts.

技术参数 Technical Data

功率等级 Power Rating	3300W
通光孔径 Clear Aperture	28mm
喷嘴规格 Nozzle Styles	单层, 双层, 非标 Single, Double, Custom

喷嘴孔口径 Diameter of Nozzle Tip	0.8mm, 1.0mm, 1.2mm, 1.5mm, 2.0mm, 2.5mm, 3.0mm, 3.5mm, 4.0mm, 4.5mm, 5.0mm
辅助气体气压 Assist Gas Pressure	≤25bar
重量 Weight	~ 3.5kg

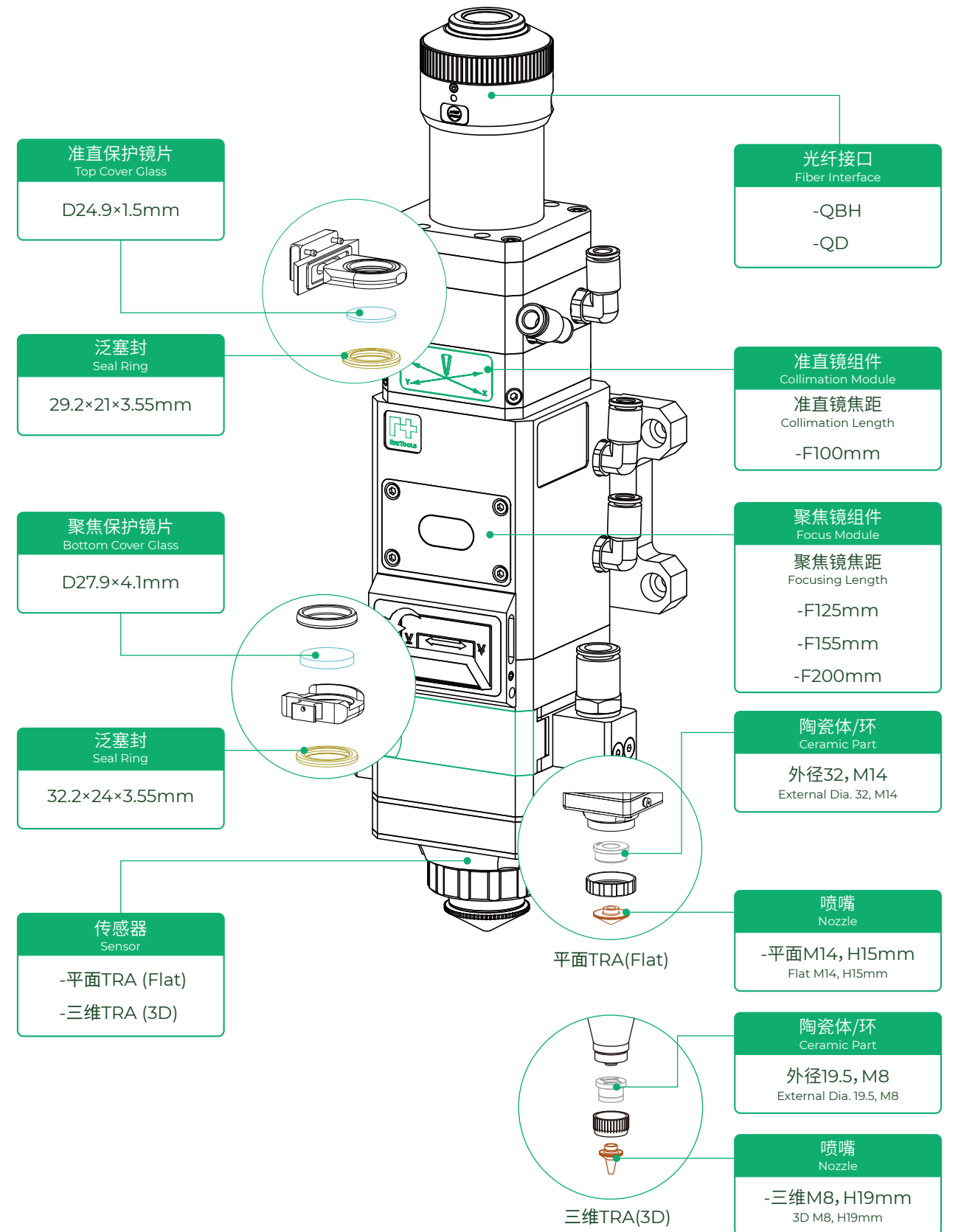

FM220

精细切割头
Micro Cutting Head

功率等级
Power Rating 0.5kW/1.5kW



更多信息请扫描二维码
Scan to get details



*产品图片仅供参考
* For Reference Only

聚焦采用多片精密透镜组成的复合透镜组

The focus module consists of combo lens with multiple optical lenses.

旋钮式焦点调节, 可对焦点进行精细调节

Knob type focus adjuster for fine adjustment.

最小刻度0.05mm, 可调范围10mm

Minimum scale 0.05mm, adjustable range 10mm.

采用抽屉式镜座, 保护镜片更换快速、简单

Drawer type cover glass holder to facilitate replacement.

适配小孔径喷嘴, 最小喷嘴孔径0.3mm

Work with small aperture nozzle, minimum nozzle aperture 0.3mm.

具备多种光纤接口, 可与各种激光器进行适配

Various fiber interfaces to work with different lasers.

可选355nm和532nm波长镜片 (定制)

Available lens includes 355nm and 532nm wavelength. (customizable)

可搭配CCD接口, 实时监控切缝, 多角度光纤接口
可选

Optional CCD interface to monitor the kerf, and optional configurations for fiber input angle. (customizable)

配带感应喷嘴连接件和高度传感器

Optional nozzle connector with sensor and height sensor.

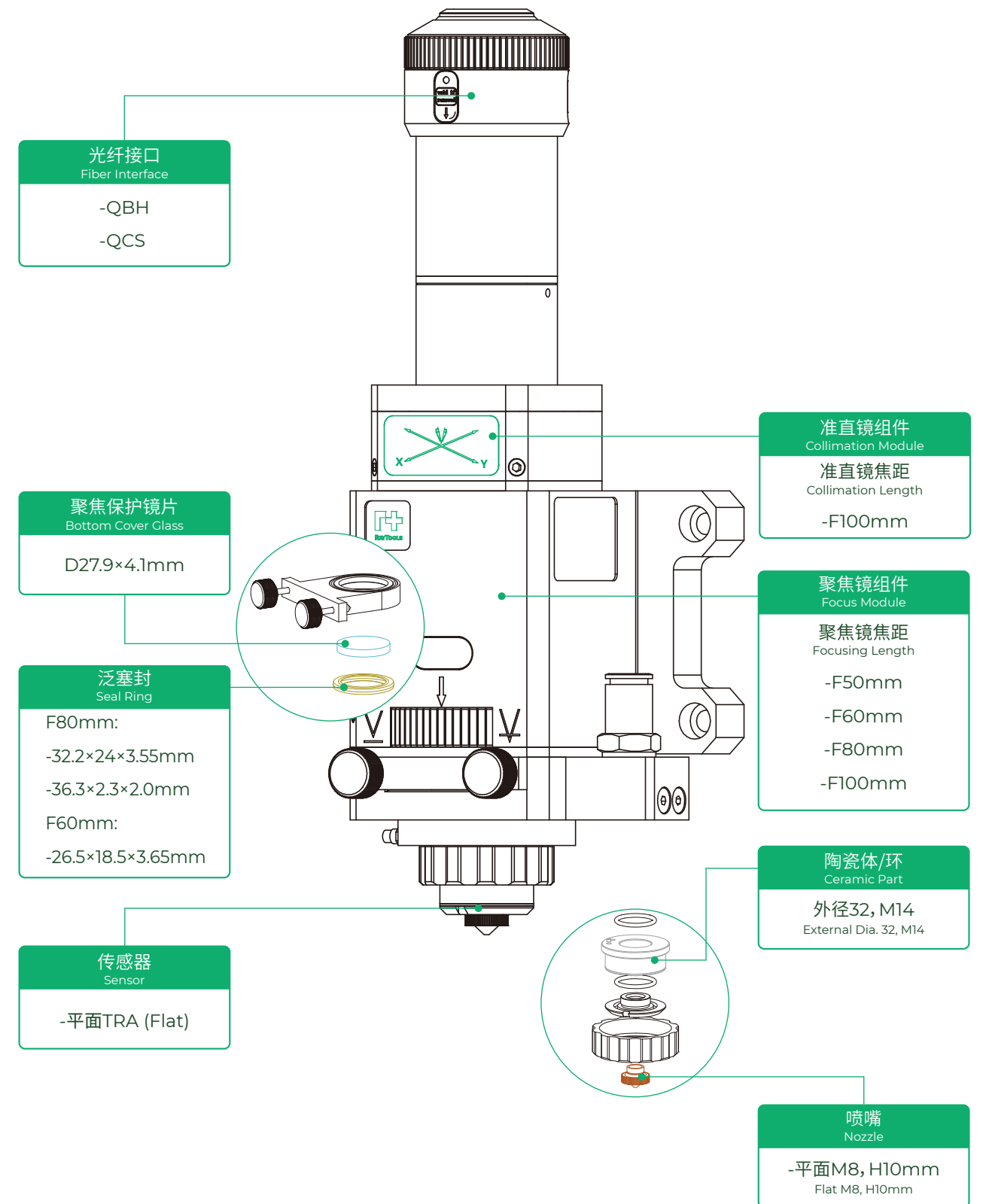

BM110

高性能自动调焦切割头

High-performance Auto Focus Cutting Head

功率等级 **3.3kW**
Power Rating

设计优异

Excellent Design

优化的光学配置和平滑高效的气流设计，
显著提高切割质量及效率

Optimized optical configuration and smooth gas circuit to improve cutting quality and efficiency significantly.

自动调焦

Auto Focus

自动调焦，减少人为干预，

自动调焦范围-12~+10mm，调焦精度0.05mm

Auto focus range is -12~+10mm and focusing accuracy is 0.05mm.



*产品图片仅供参考
* For Reference Only

技术参数 Specifications

自动调焦 Auto Focus		喷嘴孔口径 Diameter of Nozzle Tip	
- 范围 Range	-12mm ~ +10mm	0.8mm, 1.0mm, 1.2mm, 1.5mm, 2.0mm, 2.5mm,	
- 速度 Velocity	≤170mm/s	3.0mm, 3.5mm, 4.0mm, 4.5mm, 5.0mm	
- 加速度 Acceleration	≤10m/s ²	辅助气体气压 Assist Gas Pressure	≤30bar
- 精度 Accuracy	0.05mm	重量 Weight	~ 5.0kg
通光孔径 Clear Aperture	28mm		
喷嘴规格 Nozzle Styles	单层, 双层, 非标		
		Single, Double, Custom	



更多信息请扫描二维码
Scan to get details

多重保护镜片

Multiple Cover Glasses

准直增加保护镜片，有效保护准直镜片
Added cover glasses to protect the collimation lens effectively.

抽屉式镜座

Drawer Type Lens Holder

保护镜片更换快速、简单
Drawer type cover glass holder to facilitate replacement.

高适配性

High Adaptability

具备QBH和QD等多款光纤接口，
可与各种主流激光器进行适配

Various fiber interfaces like QBH, QD to work with different prevailing lasers.

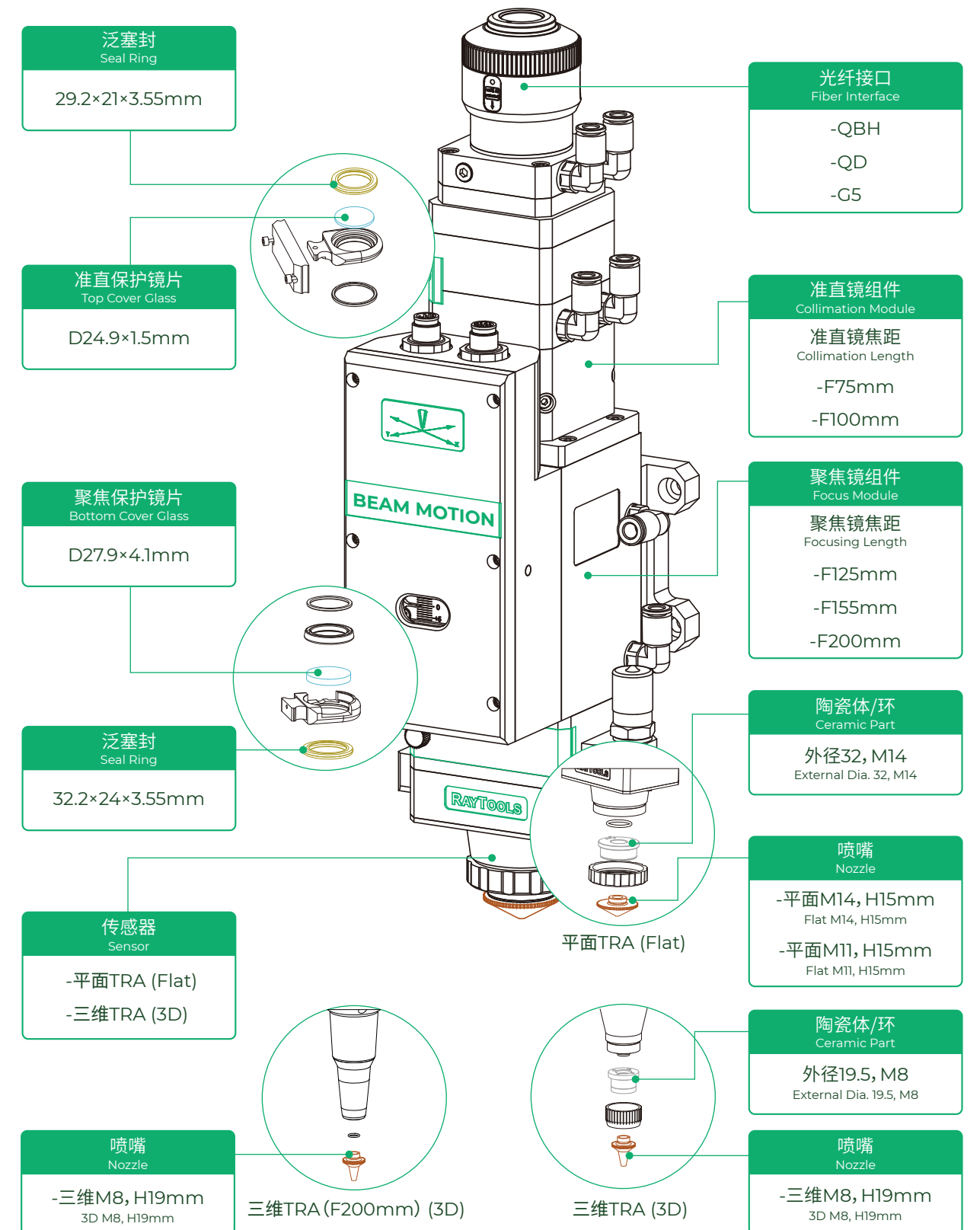

BM111

高性能自动调焦切割头

High-performance Auto Focus Cutting Head

功率等级 **3.3kW**
Power Rating

多重保护镜片

Multiple Cover Glasses

3片保护镜片, 高效保护准直、聚焦镜片
3 cover glasses to protect focus & collimation lens.

自动调焦

Auto Focus

自动调焦, 减少人为干预, 调焦速度170mm/s, 调节精度0.05mm
Auto focus to reduce human intervention. Speed up to 170mm/s and accurate to 0.05mm.



*产品图片仅供参考
* For Reference Only

技术参数 Specifications

自动调焦 Auto Focus	
- 范围 Range	-12mm ~ +10mm
- 速度 Velocity	≤170mm/s
- 加速度 Acceleration	≤10m/s ²
- 精度 Accuracy	0.05mm
通光孔径 Clear Aperture	28mm
喷嘴规格 Nozzle Styles	单层, 双层, 非标 Single, Double, Custom

喷嘴孔口径 Diameter of Nozzle Tip	0.8mm, 1.0mm, 1.2mm, 1.5mm, 2.0mm, 2.5mm, 3.0mm, 3.5mm, 4.0mm, 4.5mm, 5.0mm
辅助气体气压 Assist Gas Pressure	≤30bar
重量 Weight	~ 5.7kg



更多信息请扫描二维码
Scan to get details

高度防尘

Excellent Dustproof

IP65级防尘, 防尘无死角

IP65 class dustproof. All-around dust prevention.

高速切割

High-Speed Cutting

12mm厚SUS304切割速度
0.7m/min@3000W, 12mm厚Q235
切割速度1.2m/min@3000W

To 12mm thick SUS304, with a speed of
0.7m/min@3000W; to 12mm thick Q235,
speed of 1.2m/min@3000W.

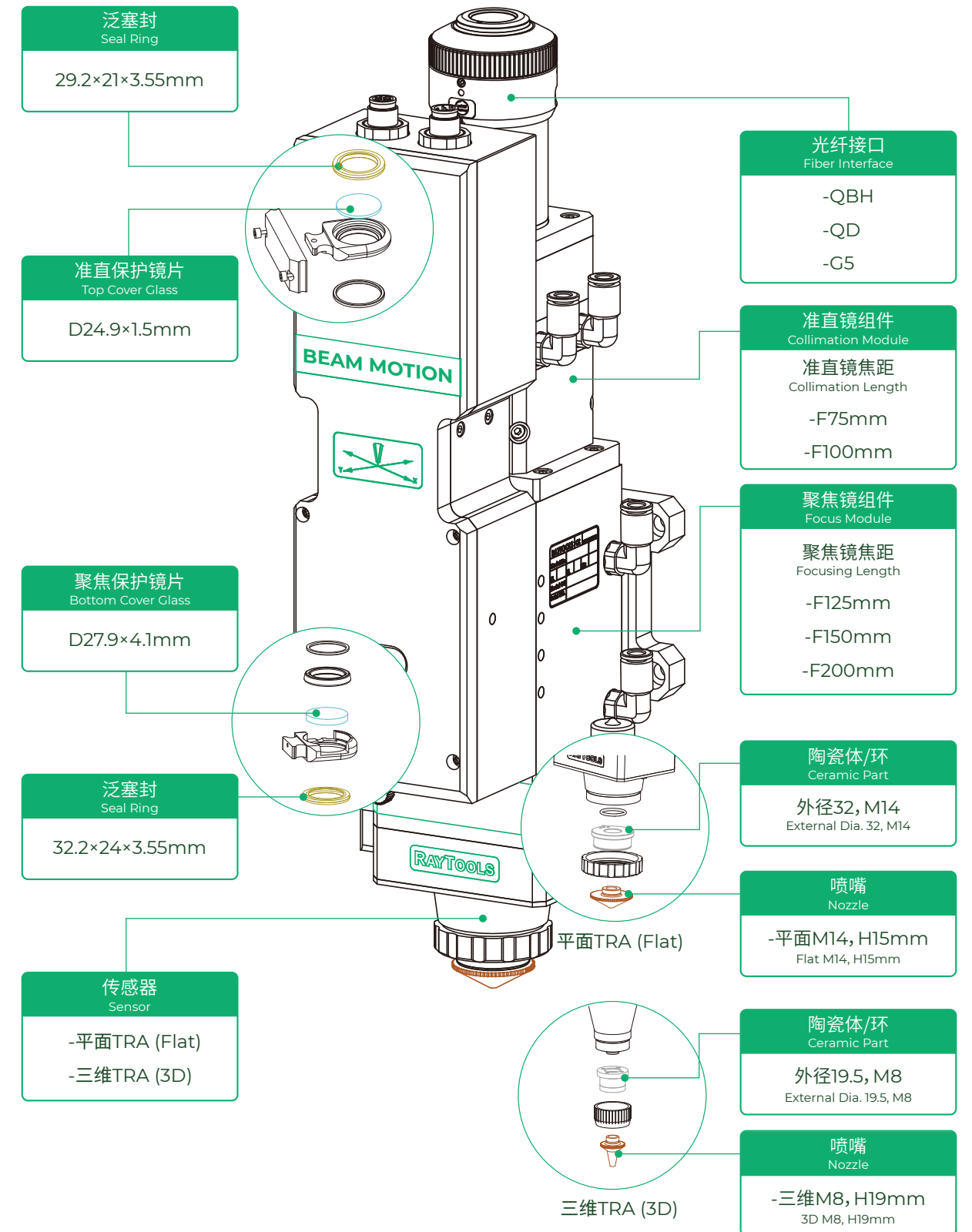

BM04K Type E



更多信息请扫描二维码
Scan to get details

高性能自动调焦切割头——ECAT版 功率等级 4kW
High-performance Auto Focus Cutting Head Power Rating



气路优化

Excellent Design
优化的光学配置和平滑高效的气流设计, 显著提高切割质量及效率
Optimized optical configuration and smooth gas circuit to improve cutting quality and efficiency significantly.

高适配性

High Adaptability
具备QBH款光纤接口, 可与各种主流激光器进行适配
With fiber interfaces like QBH to work with different prevailing lasers.

总线控制

Busfield Control
EtherCAT总线通讯及总线控制调焦单元, 使用者可以通过程序设定实现连续快速调焦
EtherCAT bus communication and focus module with busfield control enable program setting for continuous fast focusing.



*产品图片仅供参考
* For Reference Only

结构优化

Optimized Structure
抽屉式结构, 适合光学元件快速更换
Drawer type cover glass holder to facilitate replacement.

高效冷却

Efficient Water Cooling
光学组件及喷嘴处均有冷却结构, 延长持续工作时间
Built-in cooling function of optical modules and nozzle assembly to extend continuous working time.

多重保护

Multiple Cover Glasses
降低因更换下保护镜片时带来的污染造成的风险
Reduce the risk of contamination caused by replacing the protective lens.

技术参数 Technical Data

自动调焦 Auto Focus	
- 范围 Range	-12mm~+10mm
- 速度 Velocity	≤170mm/s
- 加速度 Acceleration	≤10m/s ²
- 精度 Accuracy	0.05mm
通光孔径 Clear Aperture	28mm

喷嘴规格 Nozzle Styles	单层, 双层, 非标 Single, Double, Custom
喷嘴孔口径 Diameter of Nozzle Tip	0.8mm, 1.0mm, 1.2mm, 1.5mm, 2.0mm, 2.5mm, 3.0mm, 3.5mm, 4.0mm, 4.5mm, 5.0mm
辅助气体气压 Assist Gas Pressure	≤30bar
重量 Weight	~ 4.6kg

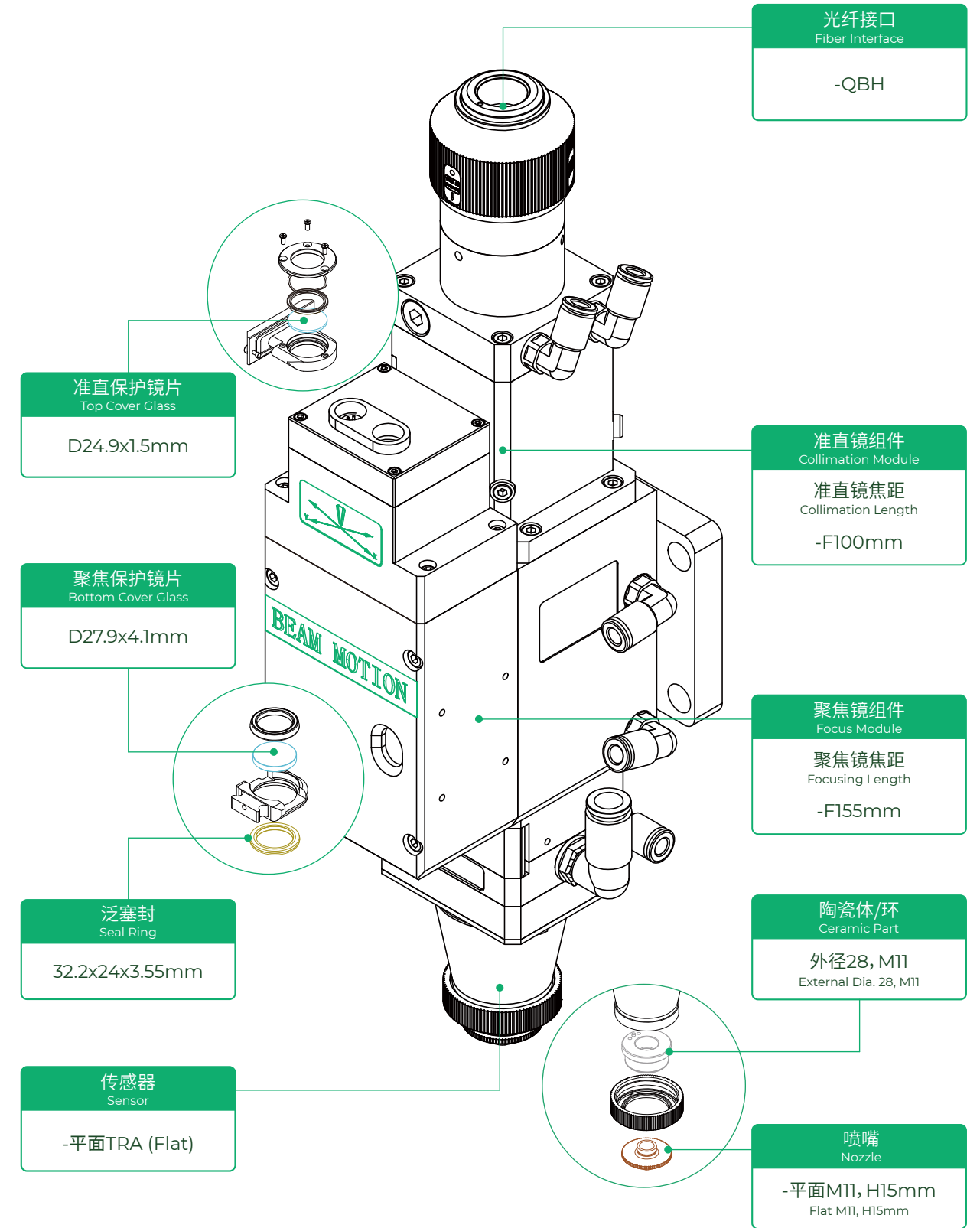

BM06K

高性能自动调焦切割头

High-performance Auto Focus Cutting Head

功率等级 **6kW**
Power Rating

高效冷却

Efficient Cooling

准直镜、聚焦镜组均有冷却结构,同时增加喷嘴冷却气流,有效保护喷嘴、陶瓷体,延长持续工作时间

Cooling structure for both collimation module and focus module, and cooling gas to nozzle which effectively protects the nozzle & ceramic part and extends the lifespan.

多重保护镜片

Multiple Cover Glasses

设计四片保护镜片,有效减少更换光纤和下保护镜片时候带来的污染,延长准直和聚焦镜片的使用寿命

4 cover glasses designed to effectively decrease contamination risk during replacement of fiber and cover glass and extend the lifespan of collimation lens and focus lens.



*产品图片仅供参考
* For Reference Only

技术参数 Specifications

自动调焦 Auto Focus	
- 范围 Range	-17mm~+17mm(F150mm) -32mm~+32mm(F200mm)
- 速度 Velocity	≤200mm/s
- 加速度 Acceleration	≤10m/s ²
- 精度 Accuracy	0.01mm
数值孔径 Numerical Aperture	0.14

喷嘴规格 Nozzle Styles	单层, 双层, 非标 Single, Double, Custom
喷嘴孔口径 Diameter of Nozzle Tip	1.0mm, 1.2mm, 1.5mm, 2.0mm, 2.5mm, 3.0mm, 3.5mm, 4.0mm, 4.5mm, 5.0mm
辅助气体气压 Assist Gas Pressure	≤30bar
重量 Weight	~ 7.5kg



更多信息请扫描二维码
Scan to get details

快速调焦

Fast Focusing

采用准直调焦,相比聚焦调焦,焦点移动速度更快,调焦范围更大
Auto focus by moving collimation lens to achieve higher speed and bigger auto focus range.

智能监控

Smart Monitoring

带有下保护镜片温度监控功能,可以通过手机APP或者电脑桌面窗口实时显示温度数据,超温输出报警,有效保护切割头光路系统
Temperature monitoring of bottom cover glass could be accessed at mobile APP or computer desktop in real-time. Alarm output for overheating to protect the optics system effectively.

优化结构设计

Optimized Structural Design

一体化机身设计,保证密封。改进QBH、QD、G5光纤接口,提升对激光器的兼容性,且不再因漏水生锈等原因卡死
Integrated design to ensure sealing. Improved fiber interface(QBH, QD, G5) to benefit their compatibility of lasers and prevent from being stuck for water leakage and rusts.

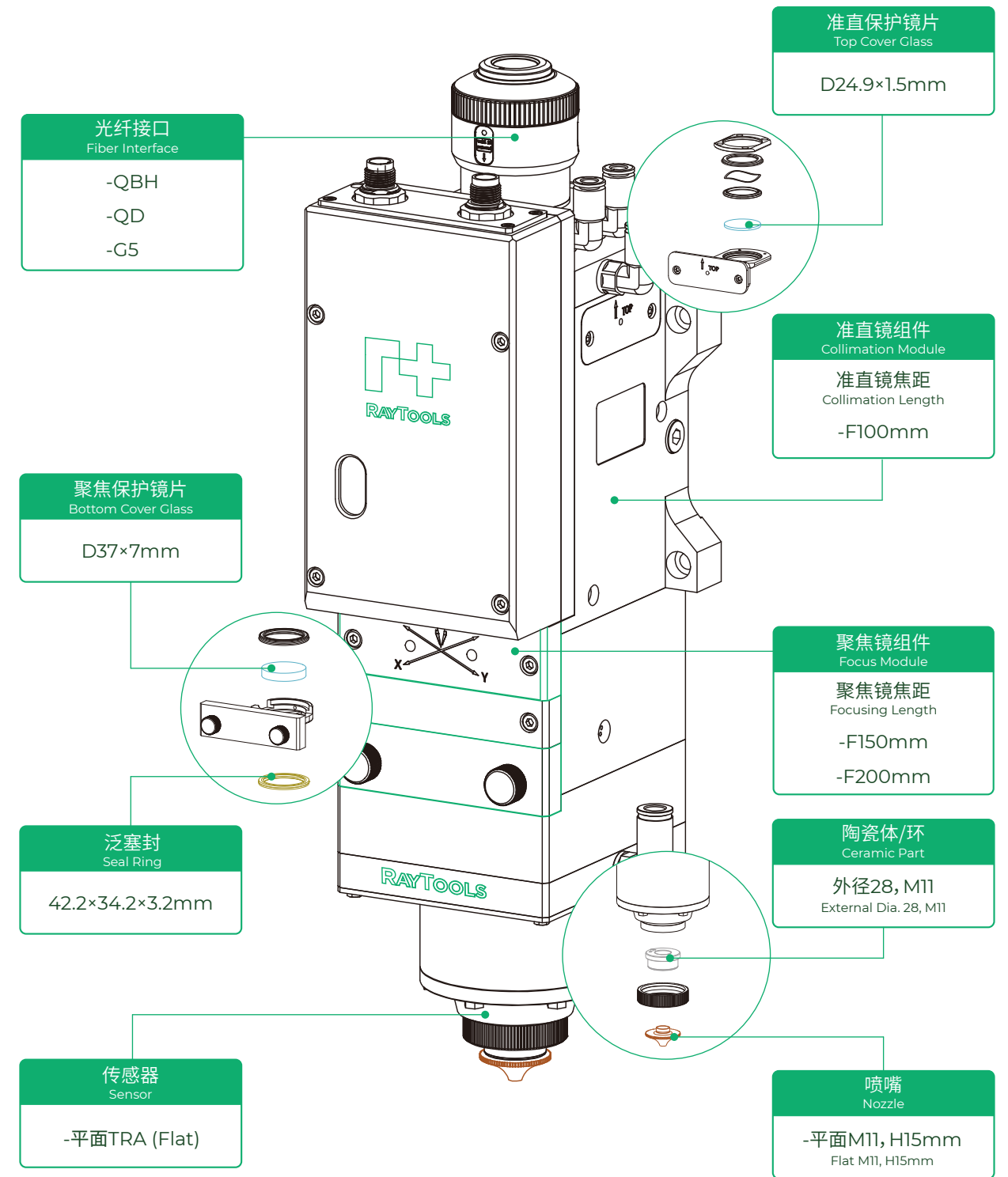

BM06K-3D

高性能自动调焦切割头

High-performance Auto Focus Cutting Head

功率等级 **6kW**
Power Rating

高效冷却

Efficient Cooling

准直镜、聚焦镜组均有冷却结构,同时增加喷嘴冷却气流,有效保护喷嘴、陶瓷体,延长持续工作时间

Cooling structure for both collimation module and focus module, and cooling gas to nozzle which effectively protects the nozzle & ceramic part and extends the lifespan.

多重保护镜片

Multiple Cover Glasses

设计四片保护镜片,有效减少更换光纤和下保护镜片时候带来的污染,延长准直和聚焦镜片的使用寿命

4 cover glasses designed to effectively decrease contamination risk during replacement of fiber and cover glass and extend the lifespan of collimation lens and focus lens.



*产品图片仅供参考
* For Reference Only

技术参数 Specifications

自动调焦 Auto Focus	
- 范围 Range	-40mm~+40mm(F200mm) -72mm~+72mm(F300mm)
- 速度 Velocity	≤200mm/s
- 加速度 Acceleration	≤10m/s ²
- 精度 Accuracy	0.01mm
数值孔径 Numerical Aperture	0.14

喷嘴规格 Nozzle Styles	单层, 双层, 非标 Single, Double, Custom
喷嘴孔口径 Diameter of Nozzle Tip	1.0mm, 1.2mm, 1.5mm, 2.0mm, 2.5mm, 3.0mm, 3.5mm, 4.0mm, 4.5mm, 5.0mm
辅助气体气压 Assist Gas Pressure	≤30bar
重量 Weight	~ 7.5kg



更多信息请扫描二维码
Scan to get details

快速调焦

Fast Focusing

采用准直调焦,相比聚焦调焦,焦点移动速度更快,调焦范围更大
Auto focus by moving collimation lens to achieve higher speed and bigger auto focus range.

智能监控

Smart Monitoring

带有下保护镜片温度监控功能,可以通过手机APP或者电脑桌面窗口实时显示温度数据,超温输出报警,有效保护切割头光路系统
Temperature monitoring of bottom cover glass could be accessed at mobile APP or computer desktop in real-time. Alarm output for overheating to protect the optics system effectively.

优化结构设计

Optimized Structural Design

一体化机身设计,保证密封。改进QBH、G5光纤接口,提升对激光器的兼容性,且不再因漏水生锈等原因卡死
Integrated design to ensure sealing. Improved fiber interface(QBH, G5) to benefit their compatibility of lasers and prevent from being stuck for water leakage and rusts.

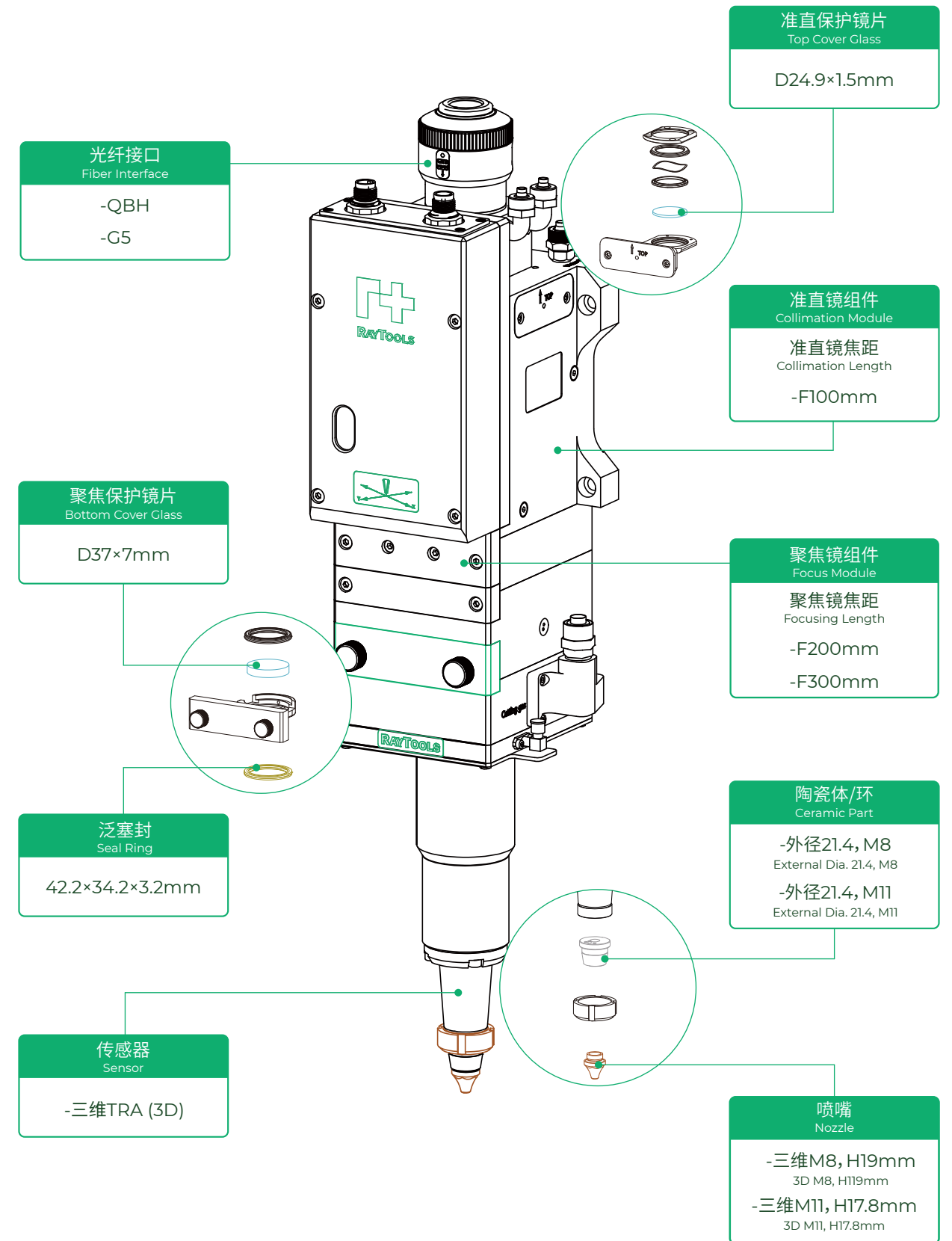

BM06K-3D-90°



更多信息请扫描二维码
Scan to get details

高性能自动调焦切割头

High-performance Auto Focus Cutting Head

功率等级 **6kW**
Power Rating

高效冷却

Efficient Cooling

准直镜、聚焦镜组均有冷却结构,同时增加喷嘴冷却气流,有效保护喷嘴、瓷体,延长持续工作时间

Cooling structure for both collimation module and focus module, and cooling gas to nozzle which effectively protects the nozzle & ceramic part and extends the lifespan.

多重保护镜片

Multiple Cover Glasses

设计四片保护镜片,有效减少更换光纤和下保护镜片时候带来的污染,延长准直和聚焦镜片的使用寿命

4 cover glasses designed to effectively decrease contamination risk during replacement of fiber and cover glass and extend the lifespan of collimation lens and focus lens.

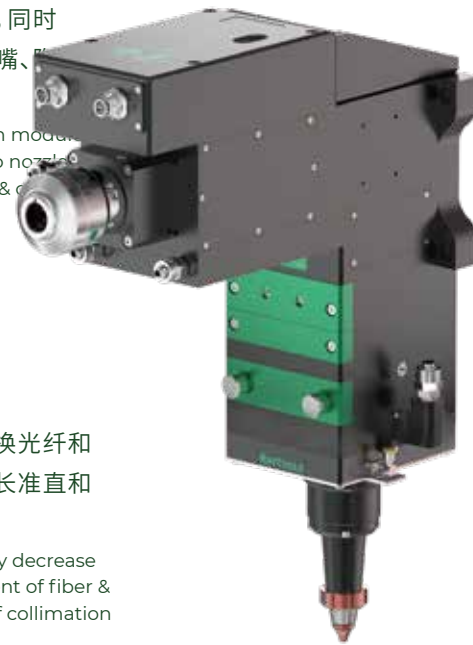

*产品图片仅供参考
* For Reference Only

技术参数 Specifications

自动调焦 Auto Focus	
- 范围 Range	-40mm~+40mm(F200mm) -72mm~+72mm(F300mm)
- 速度 Velocity	≤200mm/s
- 加速度 Acceleration	≤10m/s ²
- 精度 Accuracy	0.01mm
数值孔径 Numerical Aperture	0.14

喷嘴规格 Nozzle Styles	单层, 双层, 非标 Single, Double, Custom
喷嘴孔口径 Diameter of Nozzle Tip	1.0mm, 1.2mm, 1.5mm, 2.0mm, 2.5mm, 3.0mm, 3.5mm, 4.0mm, 4.5mm, 5.0mm
辅助气体气压 Assist Gas Pressure	≤30bar
重量 Weight	~ 7.5kg

快速调焦

Fast Focusing

采用准直调焦,相比聚焦调焦,焦点移动速度更快,调焦范围更大
Auto focus by moving collimation lens to achieve higher speed and bigger auto focus range.

智能监控

Smart Monitoring

带有下保护镜片温度监控功能,可以通过手机APP或者电脑桌面窗口实时显示温度数据,超温输出报警,有效保护切割头光路系统
Temperature monitoring of bottom cover glass could be accessed at mobile APP or computer desktop in real-time. Alarm output for overheating to protect the optics system effectively.

优化结构设计

Optimized Structural Design

一体化机身设计,保证密封。改进QBH、G5光纤接口,提升对激光器的兼容性,且不再因漏水生锈等原因卡死
Integrated design to ensure sealing. Improved fiber interface(QBH, G5) to benefit their compatibility of lasers and prevent from being stuck for water leakage and rusts.

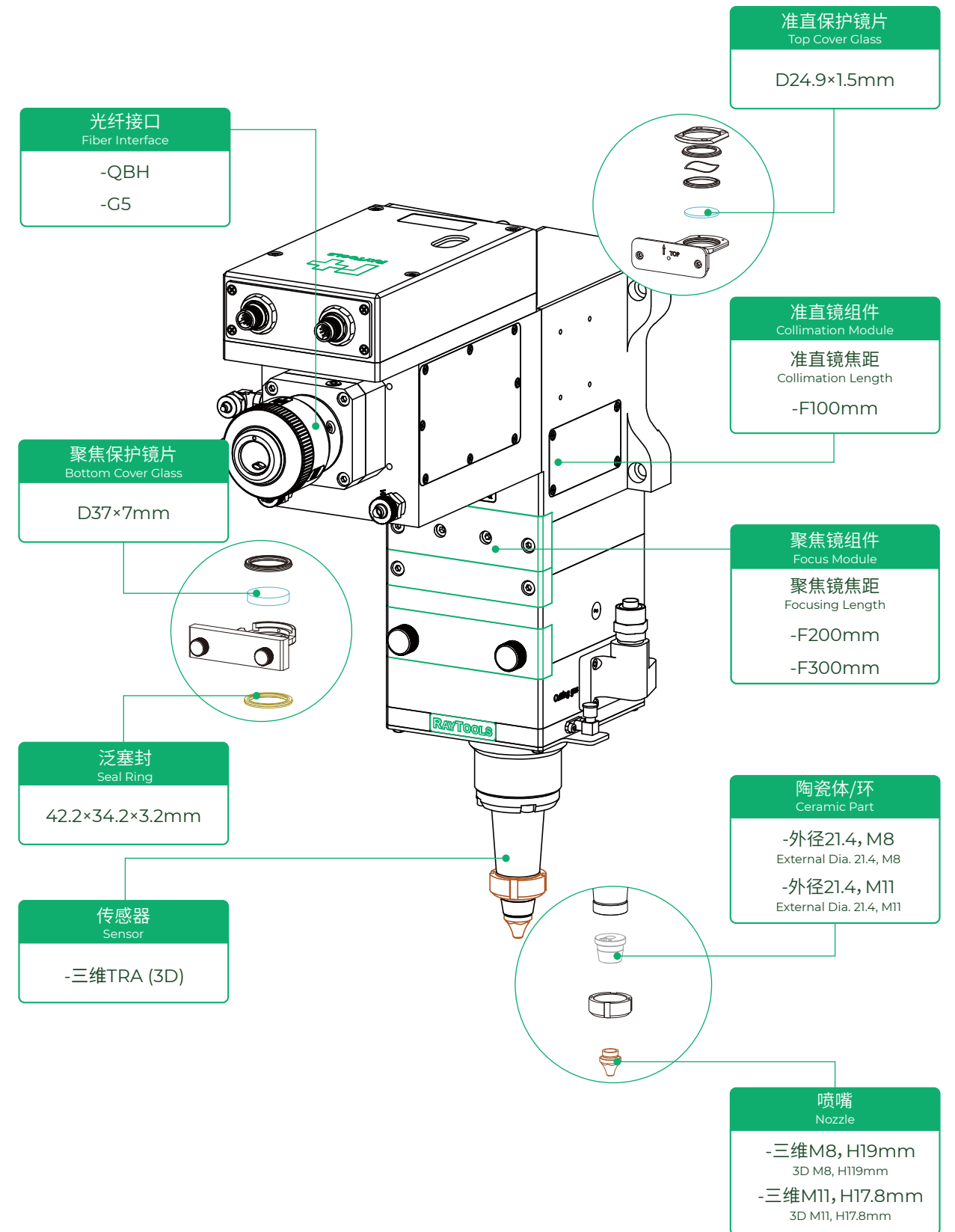

BS06K

高功率智能切割头

High Power Smart Cutting Head

功率等级

6kW/8kW

Power Rating



更多信息请扫描二维码
Scan to get details

设计优异

Excellent Design

设计轻巧, 加速度快; 同时具有优化的光学配置和平滑高效的气流设计, 显著提高切割质量及效率

Light-duty and ingenious design with high acceleration. Optimized optical configuration and smooth gas circuit to improve cutting quality and efficiency significantly.

控制方式灵活

Flexible Control Mode

支持多种接口——模拟量和脉冲来控制调焦单元, 使用者可以通过程序设定实现连续快速的焦点位置调节

Work with a variety of interfaces to control the focusing module by analog or pulse. Program setting enables continuous fast focusing.

高适配性

High Adaptability

具备QBH、QD、G5光纤接口, 可与各种主流激光器进行适配

Fiber interfaces like QBH, QD, G5 to work with various prevailing lasers.



*产品图片仅供参考
* For Reference Only

APP实时监控

App Real-time Monitoring

通过无线网络, 可在移动终端和数控系统上读取监测数据

Through WLAN, the monitored data can be read on the mobile terminal and CNC system.

参数实时反馈

Real-time Data Feedback

内置各种传感器可对切割头内部保护镜片温度、聚焦镜片温度、腔体温湿度、腔内气压、切割气体气压等加工过程中的参数实时反馈

Various built-in sensors provide real-time data feedback in processing, such as temperature inside the cutting head of the cover glass and focus lens, temperature and humidity of the cavity, and the gas pressure, etc.

技术参数 Technical Data

自动调焦 Auto Focus	
- 范围 Range	-17mm~+17mm(F150mm) -32mm~+32mm(F200mm)
- 速度 Velocity	≤200mm/s
- 加速度 Acceleration	≤10m/s ²
- 精度 Accuracy	0.01mm
数值孔径 Numerical Aperture	0.14

喷嘴规格 Nozzle Styles	单层, 双层, 非标 Single, Double, Custom
喷嘴孔口径 Diameter of Nozzle Tip	1.0mm, 1.2mm, 1.5mm, 2.0mm, 2.5mm, 3.0mm, 3.5mm, 4.0mm, 4.5mm, 5.0mm
辅助气体气压 Assist Gas Pressure	≤30bar
重量 Weight	~ 7.5kg

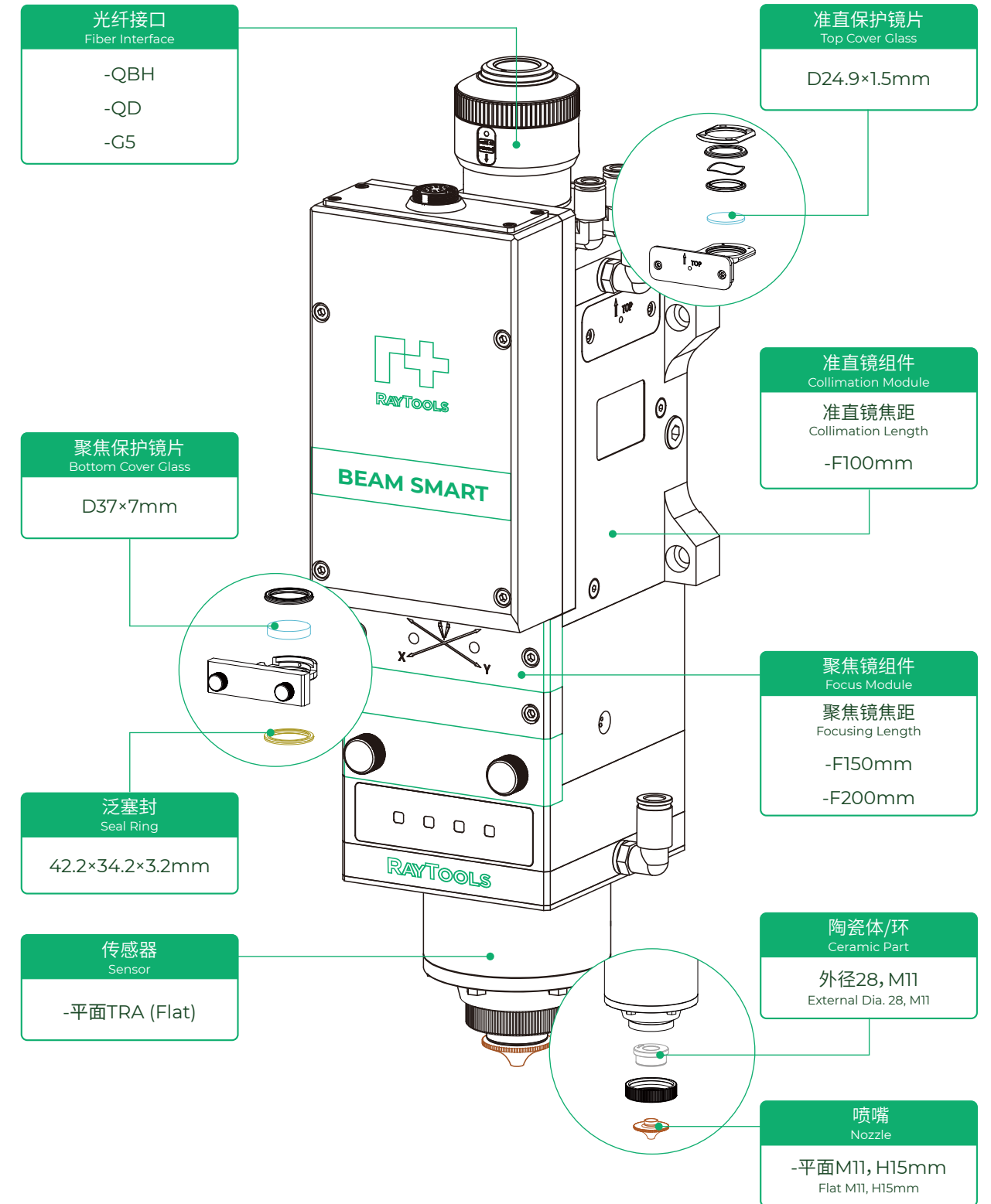

BS06K Type E



更多信息请扫描二维码
Scan to get details

高功率智能切割头——ECAT版
High Power EtherCAT Smart Cutting Head

功率等级
Power Rating 6kW/8kW



设计优异

Excellent Design

设计轻巧, 加速度快; 同时具有优化的光学配置和平滑高效的气流设计, 显著提高切割质量及效率

Light-duty and ingenious design with high acceleration. Optimized optical configuration and smooth gas circuit to improve cutting quality and efficiency significantly.

总线控制

Busfield Control

EtherCAT总线通讯及总线控制调焦单元, 使用者可以通过程序设定实现连续快速调焦
EtherCAT bus communication and focus module with busfield control enable program setting for continuous fast focusing.

高适配性

High Adaptability

具备QBH、QD和G5光纤接口, 可与各种主流激光器进行适配
Fiber interfaces like QBH, QD, G5 to work with various prevailing lasers.

技术参数 Technical Data

自动调焦 Auto Focus	
- 范围 Range	-17mm~+17mm(F150mm) -32mm~+32mm(F200mm)
- 速度 Velocity	≤200mm/s
- 加速度 Acceleration	≤10m/s ²
- 精度 Accuracy	0.01mm
数值孔径 Numerical Aperture	0.14



*产品图片仅供参考
* For Reference Only

APP实时监控

App Real-time Monitoring

通过无线网络, 可在移动终端和数控系统上读取监测数据
Through WLAN, the monitored data can be read on the mobile terminal and CNC system.

参数实时反馈

Real-time Data Feedback

内置各种传感器可对切割头内部保护镜片温度、聚焦镜片温度、腔体温湿度、腔内气压、切割气体气压等加工过程中的参数实时反馈
Various built-in sensors provide real-time data feedback in processing, such as temperature inside the cutting head of the cover glass and focus lens, temperature and humidity of the cavity, and the gas pressure, etc.

喷嘴规格 Nozzle Styles	单层, 双层, 非标 Single, Double, Custom
喷嘴孔口径 Diameter of Nozzle Tip	1.0mm, 1.2mm, 1.5mm, 2.0mm, 2.5mm, 3.0mm, 3.5mm, 4.0mm, 4.5mm, 5.0mm
辅助气体气压 Assist Gas Pressure	≤30bar
重量 Weight	~ 7.5kg

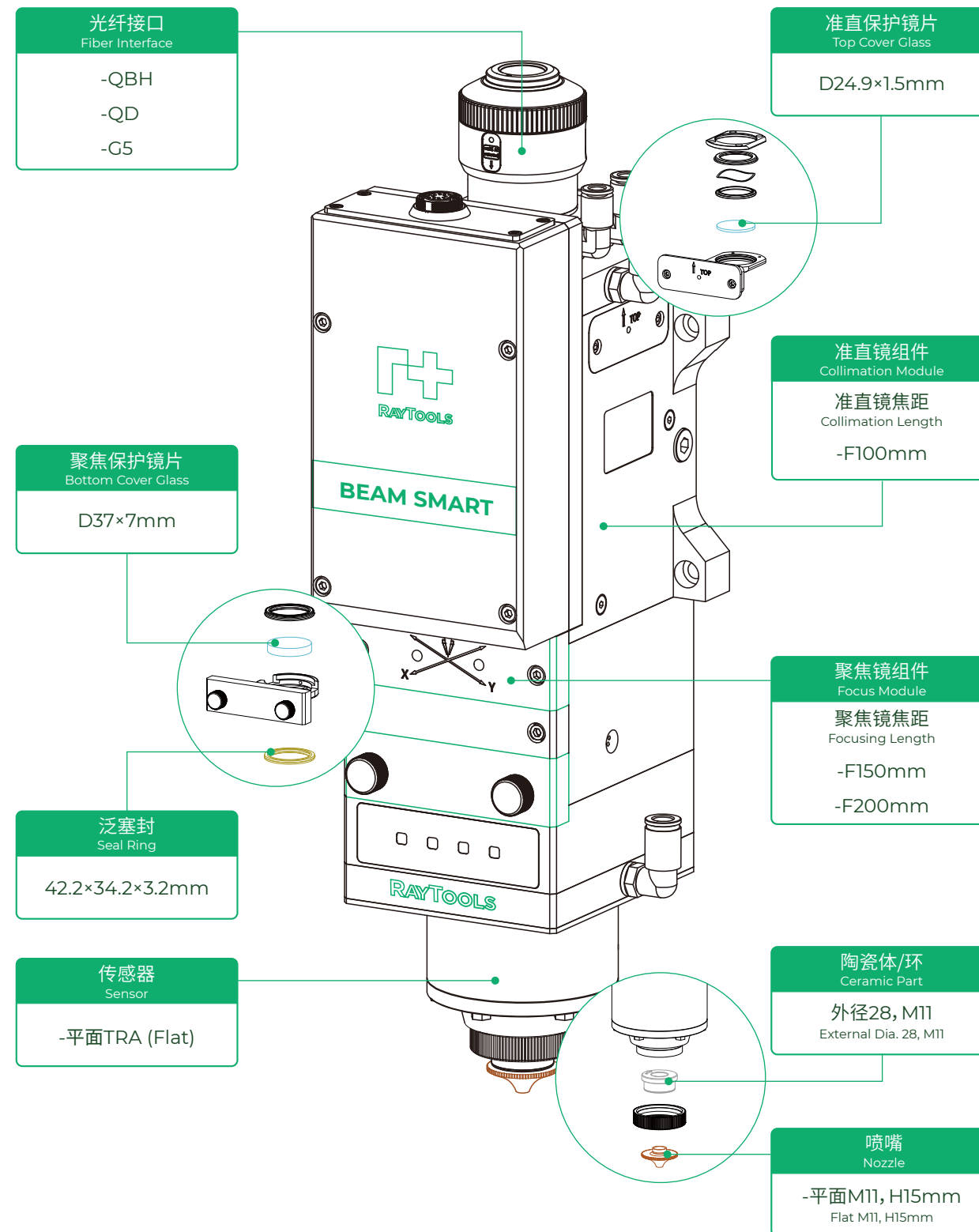

BS12K

高功率智能切割头
High Power Smart Cutting Head

功率等级 12kW
Power Rating



更多信息请扫描二维码
Scan to get details

设计优异 Excellent Design

轻量化设计, 提高机床的加速度; 取消传统的空气对喷嘴的冷却 (无需配空压机), 利用平滑高速的气流设计、透镜光学整形和出色的喷嘴水冷结构, 显著提高了在切割钢板过程中的稳定性、表面质量和效率。

Light-duty design to improve the machine acceleration; smooth and high-efficient nozzle cooling gas circuit instead of the traditional way of using air and the air compressor, with optimized optics system and excellent nozzle cooling structure to improve the stability, quality, and efficiency in cutting steel sheet.

高适配性 High Adaptability

具备QBH、QD、Q+、LOE光纤接口, 可与各种主流激光器进行适配

Fiber interfaces like QBH, QD, Q+, LOE to work with various prevailing lasers.

技术参数 Technical Data

自动调焦 Auto Focus	
- 范围 Range	-40mm~+40mm
- 速度 Velocity	≤200mm/s
- 加速度 Acceleration	≤10m/s ²
- 精度 Accuracy	0.01mm
数值孔径 Numerical Aperture	0.14

喷嘴规格 Nozzle Styles	单层, 双层, 非标 Single, Double, Custom
喷嘴孔口径 Diameter of Nozzle Tip	1.0mm, 1.2mm, 1.3mm, 1.5mm, 1.7mm, 1.9mm, 2.1mm, 2.3mm, 2.5mm, 3.5mm, 4.0mm, 5.0mm, 7.0mm
辅助气体气压 Assist Gas Pressure	≤30bar
重量 Weight	~ 8.2kg

控制方式灵活 Flexible Control Mode

支持多种接口——模拟量和脉冲来控制调焦单元, 使用者可以通过程序设定实现连续快速的焦点位置调节
Work with a variety of interfaces to control the focusing module by analog or pulse. Program setting enables continuous fast focusing.

APP实时监控 App Real-time Monitoring

通过无线网络, 可在移动终端和数控系统上读取监测数据
Through WLAN, the monitored data can be read on the mobile terminal and CNC system.

参数实时反馈 Real-time Data Feedback

内置各种传感器可对切割头内部上下保护镜片温度、聚焦镜片温度、腔体温湿度、腔内气压、切割气体气压等加工过程中的参数实时反馈
Various built-in sensors provide real-time data feedback in processing, such as temperature inside the cutting head of the cover glass and focus lens, temperature and humidity of the cavity, and the gas pressure, etc.

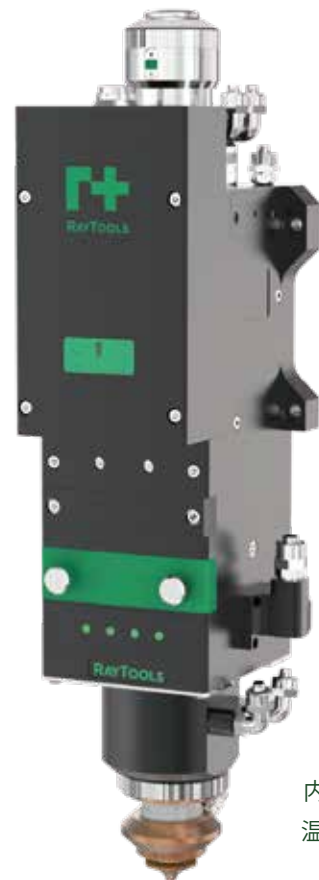

*产品图片仅供参考
* For Reference Only

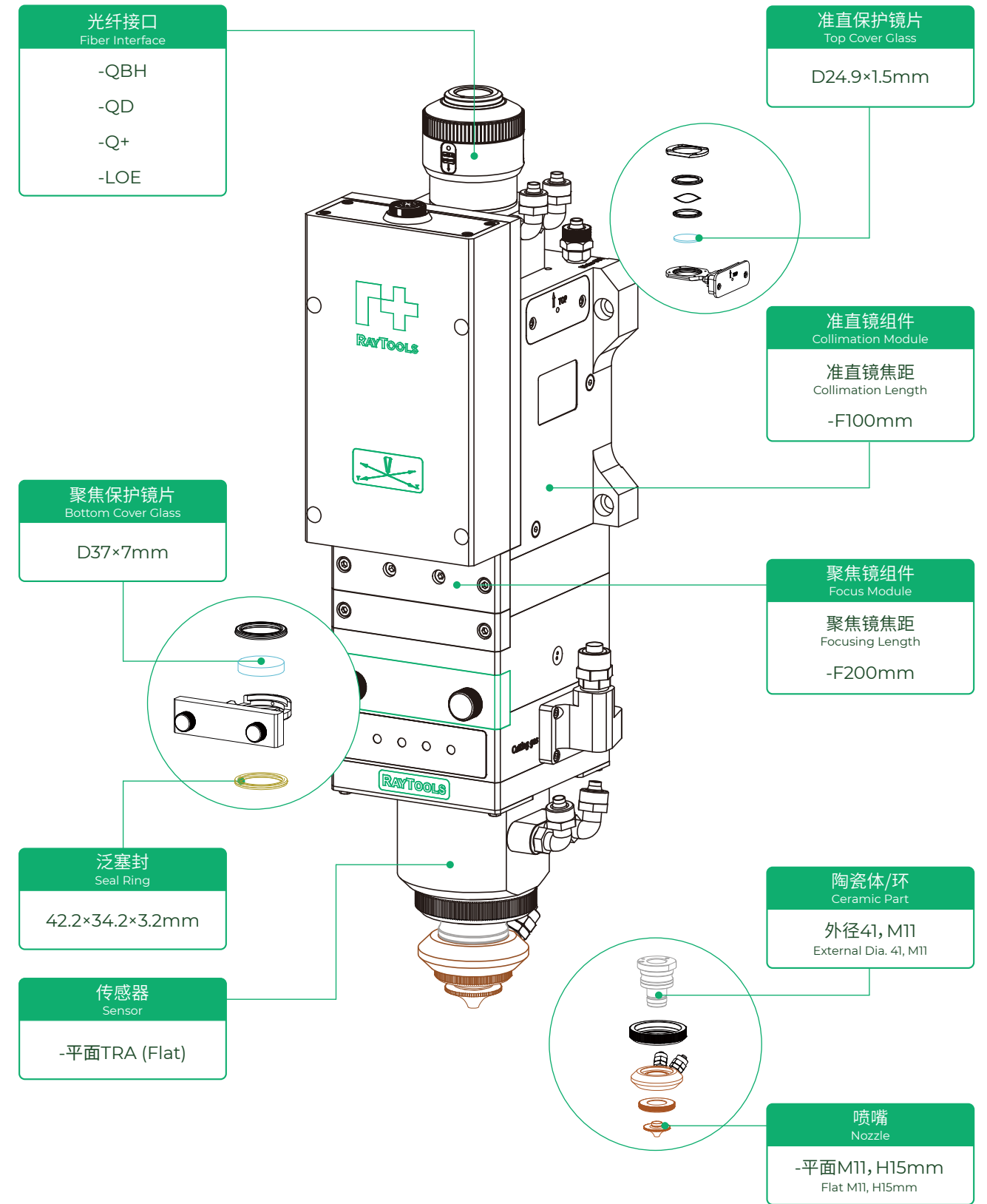

BS12K-3D

高功率智能切割头
High Power Smart Cutting Head

功率等级 12kW
Power Rating



更多信息请扫描二维码
Scan to get details

设计优异

Excellent Design

轻量化设计, 提高机床的加速度; 取消传统的空气对喷嘴的冷却 (无需配空压机), 利用平滑高速的气流设计、透镜光学整形和出色的喷嘴水冷结构, 显著提高了在切割钢板过程中的稳定性、表面质量和效率。

Light-duty design to improve the machine acceleration; smooth and high-efficient nozzle cooling gas circuit instead of the traditional way of using air and the air compressor, with optimized optics system and the original nozzle cooling structure to improve the stability, quality, and efficiency in cutting steel sheet.

高适配性

High Adaptability

具备QBH, QD, Q+, LOE光纤接口, 可与各种主流激光器进行适配

Fiber interfaces like QBH, QD, Q+, LOE to work with various prevailing lasers.

技术参数 Technical Data

自动调焦 Auto Focus	
- 范围 Range	-72mm~+72mm
- 速度 Velocity	≤200mm/s
- 加速度 Acceleration	≤10m/s ²
- 精度 Accuracy	0.01mm
数值孔径 Numerical Aperture	0.14

喷嘴规格 Nozzle Styles	单层, 双层, 非标
	Single, Double, Custom
喷嘴孔口径 Diameter of Nozzle Tip	1.2mm, 1.3mm, 1.4mm, 1.6mm, 1.8mm, 2.0mm, 3.0mm, 4.0mm, 5.0mm
辅助气体气压 Assist Gas Pressure	≤30bar
重量 Weight	~ 8.2kg



*产品图片仅供参考
* For Reference Only

控制方式灵活

Flexible Control Mode

支持多种接口——模拟量和脉冲来控制调焦单元, 使用者可以通过程序设定实现连续快速的焦点位置调节

Work with a variety of interfaces to control the focusing module by analog or pulse. Program setting enables continuous fast focusing.

APP实时监控

App Real-time Monitoring

通过无线网络, 可在移动终端和数控系统上读取监测数据

Through WLAN, the monitored data can be read on the mobile terminal and CNC system.

参数实时反馈

Real-time Data Feedback

内置各种传感器可对切割头内部上下保护镜片温度、聚焦镜片温度、腔体温湿度、腔内气压、切割气体气压等加工过程中的参数实时反馈

Various built-in sensors provide real-time data feedback in processing, such as temperature inside the cutting head of the cover glass and focus lens, temperature and humidity of the cavity, and the gas pressure, etc.

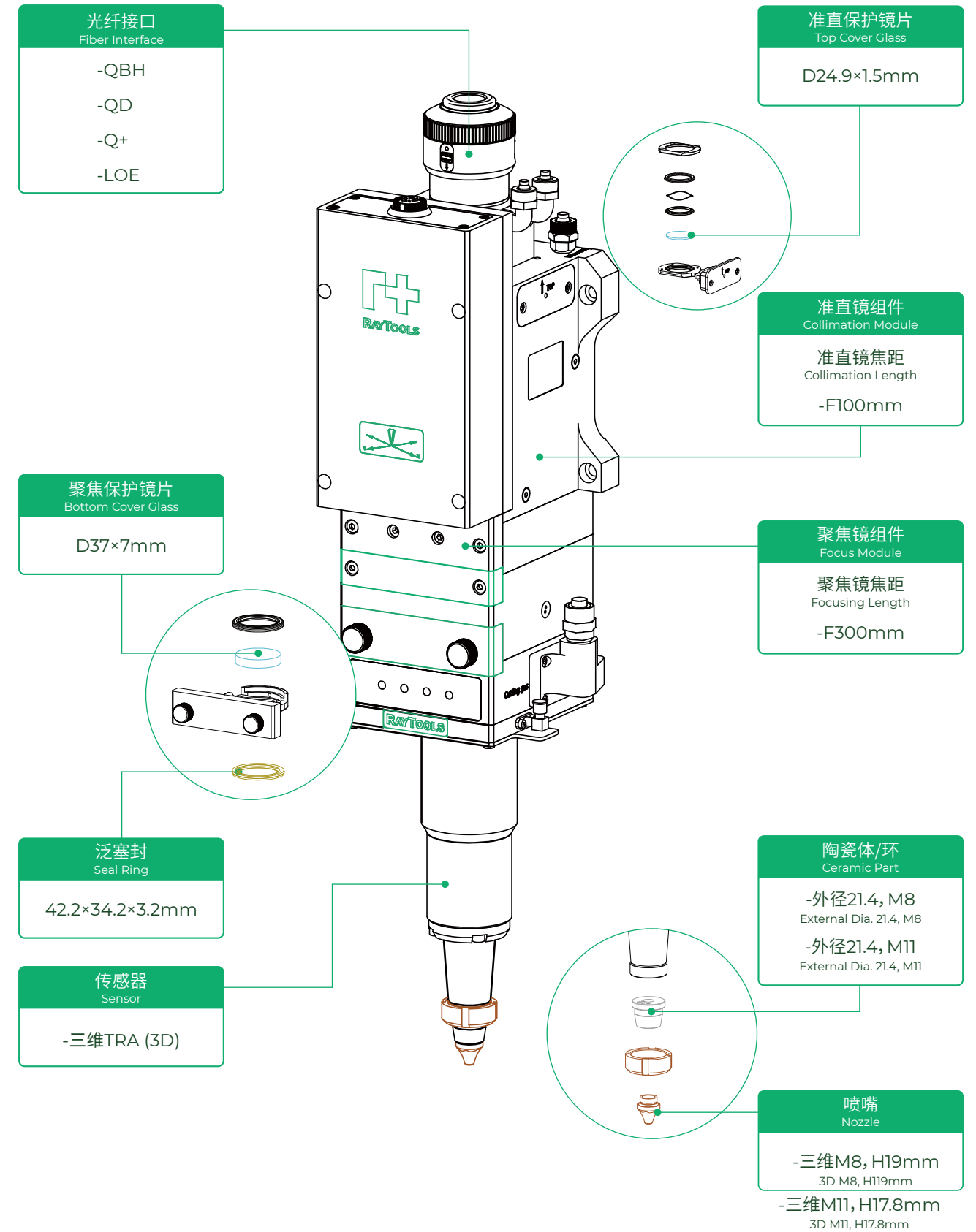

BS20K

高功率智能切割头
High Power Smart Cutting Head

功率等级 20kW
Power Rating



更多信息请扫描二维码
Scan to get details

设计优异 Excellent Design

轻量化设计, 提高机床的加速度; 取消传统的空气对喷嘴的冷却 (无需配空压机), 利用平滑高速的气流设计、透镜光学整形和国内先进的喷嘴水冷结构, 显著提高了在切割钢板过程中的稳定性、表面质量和效率。

Light-duty design to improve the machine acceleration; smooth and high-efficient nozzle cooling gas circuit instead of the traditional way of using air and the air compressor, with optimized optics system and excellent nozzle cooling structure to improve the stability, quality, and efficiency in cutting steel sheet.

高适配性 High Adaptability

具备QBH、QD、Q+、LOE等光纤接口, 可与各种主流激光器进行适配

Various fiber interfaces like QBH, QD, Q+, LOE to work with different prevailing lasers.



*产品图片仅供参考
* For Reference Only

APP实时监控

App Real-time Monitoring

通过无线网络, 可在移动终端和数控系统上读取监测数据

Through WLAN, the monitored data can be read on the mobile terminal and CNC system.

参数实时反馈

Real-time Data Feedback

内置各种传感器可对切割头内部保护镜片温度、聚焦镜片温度、腔体温湿度、腔内气压、切割气体气压等加工过程中的参数实时反馈

Various built-in sensors provide real-time data feedback in processing, such as temperature inside the cutting head of the cover glass and focus lens, temperature and humidity of the cavity, and the gas pressure, etc.

技术参数 Technical Data

自动调焦 Auto Focus	
- 范围 Range	-72mm~+72mm
- 速度 Velocity	≤200mm/s
- 加速度 Acceleration	≤10m/s ²
- 精度 Accuracy	0.01mm
数值孔径 Numerical Aperture	0.14

喷嘴规格 Nozzle Styles	单层, 双层, 非标
	Single, Double, Custom
喷嘴孔口径 Diameter of Nozzle Tip	1.0mm, 1.2mm, 1.3mm, 1.5mm, 1.7mm, 1.9mm, 2.1mm, 2.3mm, 2.5mm, 3.5mm, 4.0mm, 5.0mm, 7.0mm
辅助气体气压 Assist Gas Pressure	≤30bar
重量 Weight	~ 8.2kg

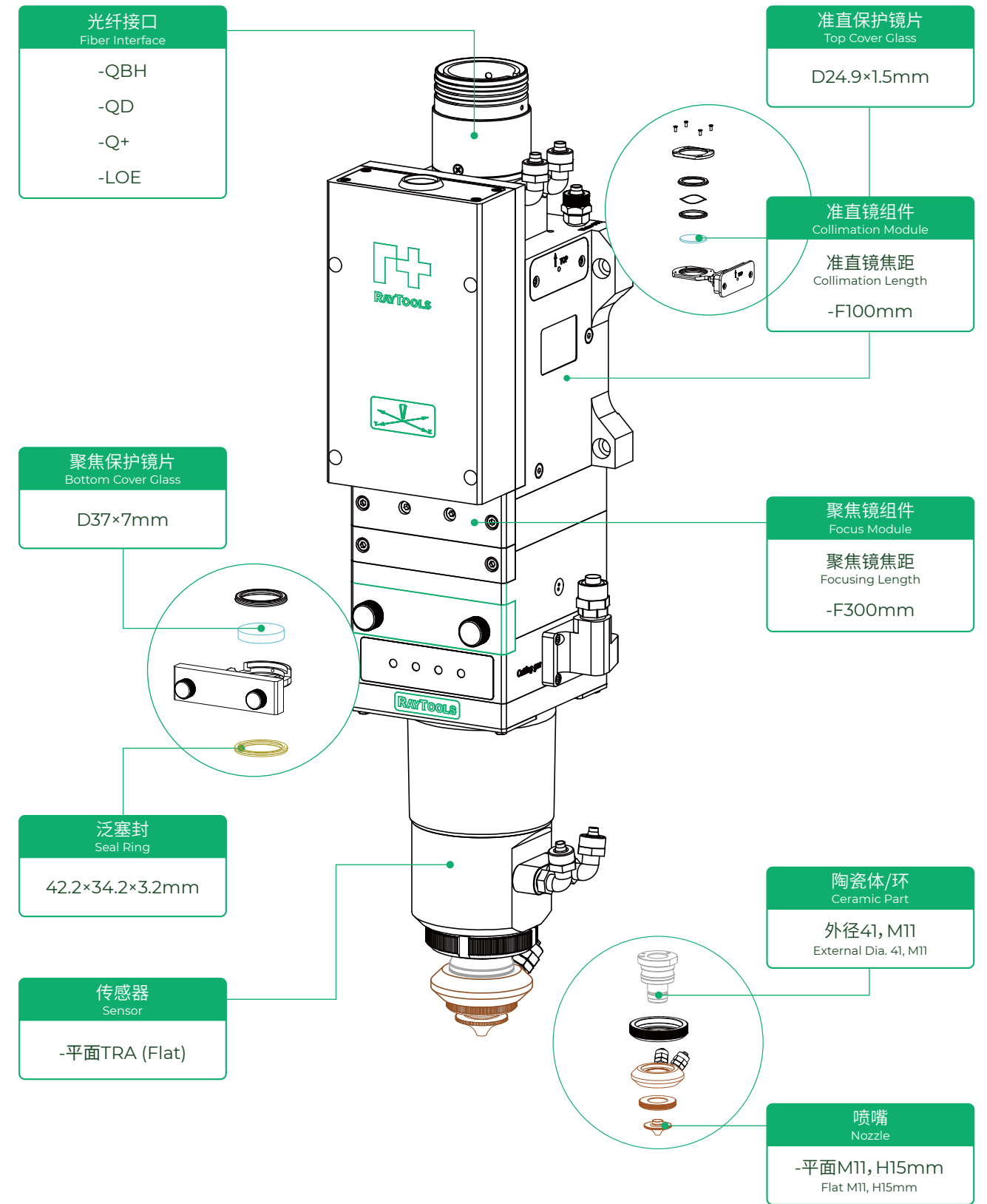

BS30K

高功率智能切割头

High Power Smart Cutting Head

功率等级

30kW



更多信息请扫描二维码
Scan to get details

APP实时监控

App Real-time Monitoring

加工状态实时反馈, 数据无线传输, 可通过APP实时监控, LED即时显示当前的系统状态

Real-time feedback on working status and wireless data transmission by monitoring through APP, and real-time display of system status on LED.

自动调焦

Manual Focus

采用透镜调节

Focus adjustment with optical lens.

切割稳定

Cutting Stability

喷嘴冷却和板面吹渣功能, 有效保证切割稳定

Nozzle cooling and slag blowing functions effectively ensure the cutting stability.

模块化设计

Modular Design

维护更便捷, 内部多传感器检测, 集成总线, 安装布线更简单

Easy maintenance, internal multi-sensor monitoring, integrated busfield, simple installation and wiring.

技术参数 Specifications

光纤接口 Fiber Interface	QD, Q+
通光孔径 Clear Aperture	44.5mm
手动调焦	
- 范围 Range	-50mm~+50mm
- 精度 Accuracy	0.05mm
保护镜片 Cover Glasses	
- 准直保护 Top	Φ38.1mm×1.6mm
- 聚焦保护 Bottom	Φ50mm×8mm
- 透镜 Optical Lens	D50.8-F150-F350

喷嘴规格 Nozzle Styles	双层 Double
喷嘴孔规格 Diameter of Nozzle Tip	
	2.0mm, 2.5mm, 3.0mm, 3.5mm, 4.0mm, 4.5mm, 5.0mm
辅助气体气压 Assist Gas Pressure	≤30bar
重量 Weight	~12.7kg

BD04K

三维管切切割头
3D Tube Cutting Head

功率等级
Power Rating **4kW**



更多信息请扫描二维码
Scan to get details

设计优异

Excellent Design

设计轻巧, 加速度快; 同时具有优化的光学配置和平滑高效的气流设计, 显著提高切割质量及效率

Light-duty and ingenious design with high acceleration. Optimized optical configuration and smooth gas circuit to improve cutting quality and efficiency significantly.

高适配性

High Adaptability

具备QBH和G5等多款光纤接口, 可与各种主流激光器进行适配

Various fiber interfaces like QBH and G5 to work with different prevailing lasers.



*产品图片仅供参考
* For Reference Only

密闭的光路保护

Fully Sealed Optics System

良好的密封性, 保持光路的洁净
Good sealing to keep beam path clean.

自动光斑调节

Auto Focus

自动变换焦点位置
Automatically change the focus position.

技术参数 Technical Data

功率等级 Power Rating	4000W
光学配比 Optical Configuration	100/150、100/200
光中心调节方式 Beam Alignment	准直调节 Auto Focus by Moving Collimation Lens
光中心调节范围 Beam Alignment Range	±1.5mm

焦点调节方式 Focus Adjust Mode	聚焦调节 Auto Focus by Moving of Focus Lens
焦点调节行程 Focal Adjustment Travel	-12mm~+10mm
重量 Weight	~4.8kg

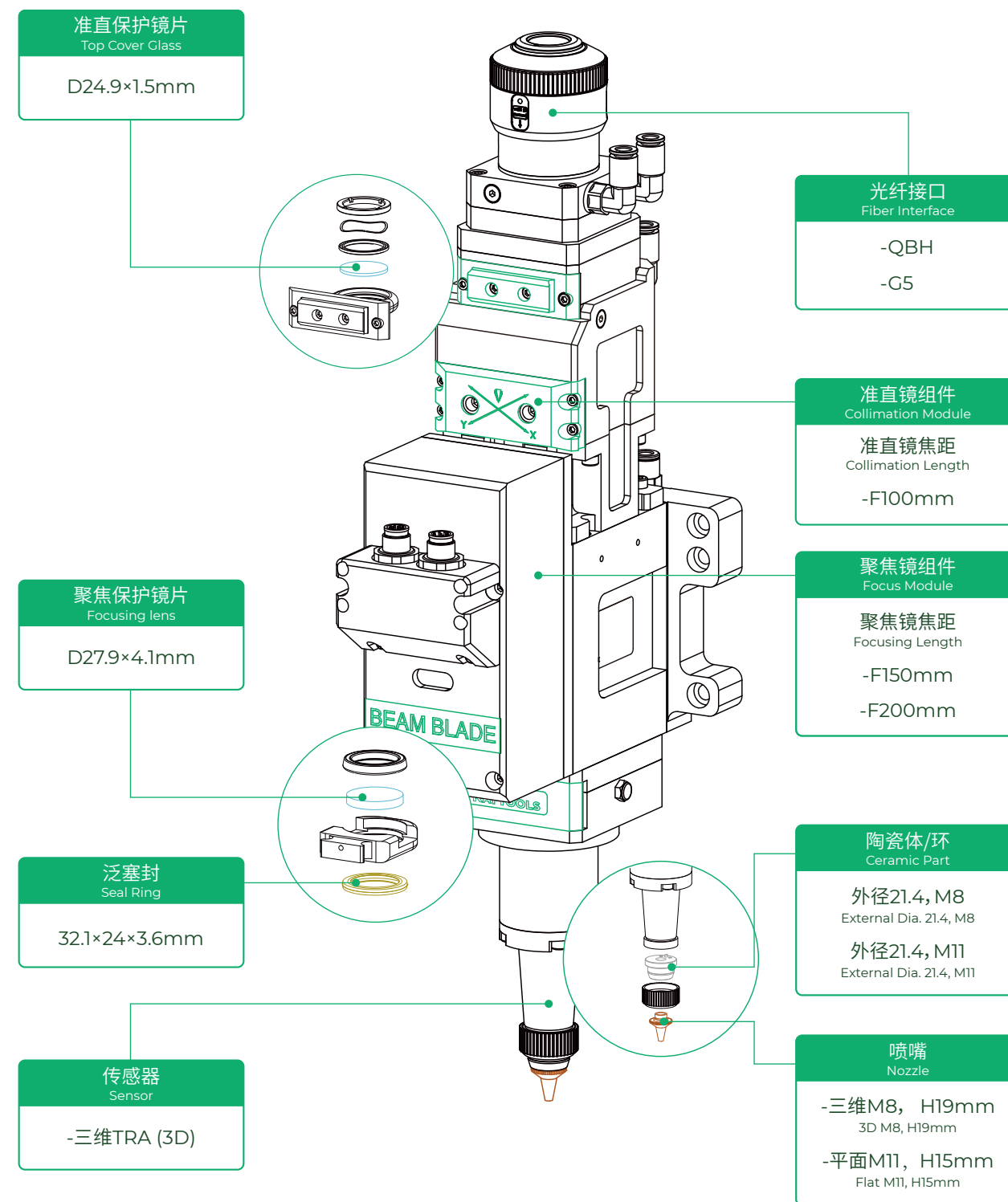

GF101

3D 机器人手动调焦切割头

Manual Focus 3D Robot Cutting Head

功率等级 **4kW**
Power Rating

高适用性

High Applicability

优化的光学配置和平滑高效的气流设计, 满足不同应用的薄板切割及其它定制需求的三维激光切割环境

Optimized optical configuration and smooth gas circuit for different applications of thin plate cutting and other customized 3D laser cutting applications.

轻量一体化设计

Light-duty Compact Design

轻量化一体化设计, 机身仅重约3.5kg, 减少机器人负载

Light-duty and all-in-one design, body weighs about 3.5kg, reducing the payload of the robot.

高度密封

Fully Sealed

牢靠的密封性、模块化的细长喷嘴设计, 减少工件干涉, 降低停机时间, 延长使用寿命

Reliable sealing, modular and skinny nozzle structure to reduce workpiece interference and prolong lifespan.



*产品图片仅供参考
* For Reference Only



更多信息请扫描二维码
Scan to get details

随动功能内置

Built-in Follow System

该产品内置随动单元, 通过线性机构驱动聚焦随动模块在一定范围内自动变更位置

Position of the built-in follow module can be changed automatically in a certain range driven by the linear mechanism.

高度防尘

Excellent Dustproof

准直镜上面增加了抽屉式镜座的保护镜, 可有效防止因灰尘而导致的准直镜片损毁
Cover glass with a drawer type holder is added to the collimation module to effectively prevent the collimation lens damage due to dust.

技术参数 Technical Data

手动调焦 Manual Focus	
- 范围 Range	-9mm ~ +7mm
- 精度 Accuracy	0.05mm
随动行程 Follow Distance	20mm
光纤接口 Fiber Interface	QBH, QD
通光孔径 Clear Aperture	28mm
准直镜焦距 Collimation Length	75mm, 100mm
聚焦镜焦距 Focusing Length	125mm, 150mm

保护镜片 Cover Glasses	
- 准直保护 Top	Φ24.9mm×1.5mm
- 聚焦保护 Bottom	Φ27.9mm×4.1mm
喷嘴规格 Nozzle Styles	单层、双层 Single, Double
喷嘴孔口径 Diameter of Nozzle Tip	0.8mm, 1.0mm, 1.2mm, 1.5mm, 2.0mm, 2.5mm, 3.0mm
辅助气体气压 Assist Gas Pressure	≤25bar
重量 Weight	~3.5kg

GF101F

3D 机器人自动调焦切割头

Auto Focus 3D Robot Cutting Head

功率等级 **4kW**
Power Rating

高适用性

High Applicability

优化的光学配置和平滑高效的气流设计, 满足不同应用的薄板切割及其它定制需求的三维激光切割环境

Optimized optical configuration and smooth gas circuit for different applications of thin plate cutting and other customized 3D laser cutting applications.

轻量一体化设计

Light-duty Compact Design

轻量化一体化设计, 机身重约6.5kg, 减少机器人负载

Light-duty and all-in-one design, body weighs about 6.5kg, reducing the payload of the robot.

高度密封

Fully Sealed

牢靠的密封性、模块化的细长喷嘴设计, 减少工件干涉, 降低停机时间, 延长使用寿命

Reliable sealing, modular and skinny nozzle structure to reduce interference and prolong lifespan.



*产品图片仅供参考
* For Reference Only



更多信息请扫描二维码
Scan to get details

自动调焦

Auto Focus

易于快速穿孔和自动换板
Easy to fast piercing and automatic plate change.

随动功能内置

Built-in Follow System

该产品内置随动单元, 通过线性机构驱动聚焦随动模块在一定范围内自动变更位置

Position of the built-in follow module can be changed automatically in a certain range driven by the linear mechanism.

高度防尘

Excellent Dustproof

准直镜上面增加了抽屉式镜座的保护镜, 可有效防止因灰尘而导致的准直镜片损毁

Cover glass with a drawer type holder is added to the collimation module to effectively prevent the collimation lens damage due to dust.

技术参数 Technical Data

自动调焦 Auto Focus	
- 范围 Range	-9mm ~ +7mm
- 精度 Accuracy	±0.05mm
随动行程 Follow Distance	20mm
光纤接口 Fiber Interface	QBH
通光孔径 Clear Aperture	28mm
准直镜焦距 Collimation Length	100mm
聚焦镜焦距 Focusing Length	125mm

保护镜片 Cover Glasses	
- 准直保护 Top	Φ24.9mm×1.5mm
- 聚焦保护 Bottom	Φ27.9mm×4.1mm
喷嘴规格 Nozzle Styles	单层、双层 Single, Double
辅助气体气压 Assist Gas Pressure	≤25 bar
重量 Weight	~6.5 kg

GF102

机器人用小轮廓插补子系统

Small Contour Interpolation Subsystem for Robot



更多信息请扫描二维码
Scan to get details

应用于

机器人三维切割领域

Applied to 3D Robot Cutting Field



用于高精度小轮廓切割

Applicable to High Precision Small Contour Cutting

可以实现机器人高精度和高速度的切割, 最小切割轮廓直径1mm的圆, 精度可达±0.1mm

Used for high precision and high speed robotic cutting, with minimum cutting diameter to be 1mm, and accuracy to reach ±0.1mm.

结构优异

Excellent Structure

结构紧凑, 体积小, 重量轻, 可以实现与机器人的完美结合

Compact structure with compact size and light weight to enable perfect integration with robots.

内置随动

Built-in Follow System

内置随动功能, 无需有机器人来完成复杂的随动运动

Built-in follow function, no need for robot to complete the complicated follow-up motion.

内置预设图形

Built-in Preset Graphics

内置128种预设图形, 无需示教编程

Preset 128 types of graphics, no need for teach programming.

附带切割软件

Built-in Cutting Software

丰富的人机界面, 功能全面, 操作便捷

Content-rich HMI interface, comprehensive functions and convenient operation.

支持I/O监控

Support for I/O Monitoring

丰富的软件工艺, 选择预设切割图形

Content-rich software for the selection of preset cutting graphics.

GF101技术参数 Technical Data

功率等级 Power Rating	4000W
通光孔径 Clear Aperture	28mm
保护镜片 Cover Glasses	
- 准直保护 Top	Φ24.9mm×5mm
- 聚焦保护 Bottom	Φ27.9mm×1mm
手动调焦范围 Manual Focus Range	-9mm ~ +7mm
随动行程 Follow Distance	20mm
辅助气体气压 Assist Gas Pressure	≤25bar
重量 Weight	~3.5kg

双轴旋转结构

Dual Axis Rotational Structure

最大切割直径 Cutting Dia.-Max	45mm
单轴最大速度 Single-Axis Speed-Max	75r/min
单轴最大加速度 Single-Axis Acceleration-Max	137rad/s ²
定位精度 Positioning Accuracy	±0.02mm
重复定位精度 Repeated Positioning	±0.01mm
重量(适配GF101切割头) Weight(for GF101)	~11.0kg

GF402

四轴管材坡口切割头

Four-Axis Tube Bevel Cutting Head

功率等级

6kW



更多信息请扫描二维码
Scan to get details

适用于激光管材坡口切割

Applicable to laser tube bevel cutting.

光路全内置

Fully built-in optics system.

准直调焦, 调焦范围可达±20mm

Focus by moving collimation lens with a range up to ±20mm.

内置随动调高功能, 随动范围±17.5mm

Built-in height follow system with a range of ±17.5mm.

摆动轴及随动轴采用无框电机+圆光栅驱动结构, 体积紧凑, 精度高, 动态性能好

Bevel axis and follow axis can be driven by a driving structure consists of frameless motor and circular grating, with compact design, high precision and outstanding dynamic performance.

摆动轴抱闸功能, 防止意外断电时碰撞工件

Brake function of the bevel axis to prevent the collision with workpiece while accidental power outages.

切割头防撞功能, 与工件碰撞后, 输出报警信号; 复位精度高, 免于碰撞后二次矫正

The anti-collision function of the cutting head to output an alarm signal after collision with the workpiece. High accuracy of reset for no need of re-correction after collision.

技术参数 Technical Data

功率等级 Power Rating	6000W
A轴行程 A-axis Travel	±135°
H轴行程 H-axis Travel	±17.5mm
调焦范围 Focus Range	±20mm
A轴速度 A-axis Speed	2rev/s
A轴加速度 A-axis Acceleration	125rad/s ²
H轴加速度 H-axis Acceleration	2g

A轴定位精度	±0.005°
A-Axis Positioning Accuracy	±0.005°
A轴重复定位精度	±0.005°
A-Axis Repeated Positioning Accuracy	±0.005°
重量 Weight	~17.5kg

GF403

单摆直角输出激光头

Orthogonal Output Uniaxial Bevel Laser Head

功率等级
Power Rating

根据激光头功率

Based on specific power rating of the laser head

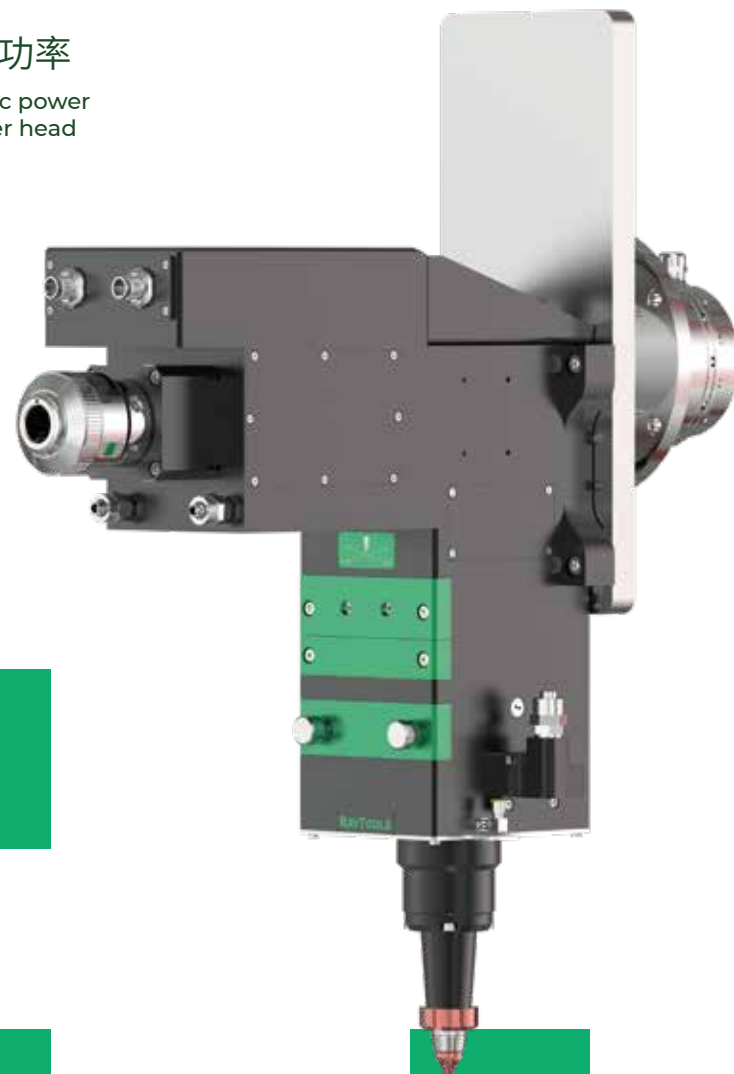

更多信息请扫描二维码
Scan to get details

整头采用航空铝材料, 经精密加工而成

The whole head is made of aviation aluminum material by micromachining.

光纤经QBH接口, 进入切割头

The optical fiber connects with the cutting head by QBH interface.

摆动轴通过精密电动执行器带动切割头旋转 $\pm 45^\circ$

The bevel axis drives the cutting head to rotate $\pm 45^\circ$ by the precise electric actuator.

调焦轴通过直线模组带动聚焦镜移动调节焦点位置

The focus axis adjust the focus position by the linear motorized module which drives the movement of focus lens.

切割头光纤接口直角输出, 方便用户摆放光纤位置

The fiber interface of the cutting head is an orthogonal output for convenient placement of the fiber laser.

整头刚度好, 更好的保证精度及切割稳定性

Good rigidity of the whole head to better ensure the accuracy and cutting stability.

技术参数 Technical Data

功率等级 Power Rating	根据激光头功率 Based on specific power rating of the laser head	加速度 Acceleration	
数值孔径 Numerical Aperture	0.14	- 摆动轴最大加速度 Bevel Axis-Max	125rad/s ²
摆动行程 Bevel Range	$\pm 45^\circ$	- 调焦轴加速度 Focus Axis	$\leq 10\text{m/s}^2$
焦距调节范围 Focus Range	-40mm~+40mm	精度 Accuracy	
光学配比 Optical Configuration	100: 200	- 摆动轴定位精度 Bevel Axis Positioning	0.005°
速度 Speed		- 调焦轴定位精度 Focus Axis Positioning	0.01mm
- 摆动最大速度 Bevel-Max	2rev/s	重量 Weight	~ 9.5kg
- 调焦速度 Focus	$\leq 200\text{mm/s}$		

GF501

五轴三维激光切割头

Five-Axis 3D Laser Cutting Head

功率等级

3kW



更多信息请扫描二维码
Scan to get details

先进、无接触、高性能电机驱动技术, 保证了良好的动态性能

Advanced, contactless, high-performance motor-driven technology to ensure a good dynamic performance.

雷尼绍圆光栅, 全闭环控制

With Renishaw circular grating and fully close-loop control.

AO自适应镜自动调焦, 调焦范围±10mm

Auto focus by AO deformable mirror with a focus range of ±10mm.

聚焦X-Y方向调中单元

X/Y alignment module.

TRA先进防碰撞系统, 意外碰撞, 自动停机, 自复位精度高

Advanced anti-collision TRA system with auto-stop function for accidental collision, and high accuracy of auto-reset.

A轴自动刹车系统, 防止意外断电时撞击工件

Auto-brake system of A axis to prevent accidental power outages and any collision with workpiece.

内置H轴随动升降系统, 行程±18.5mm

Built-in H-axis height follow system with a follow distance of ±18.5mm.

准直, 聚焦, 电机, 高效、直接全闭环冷却水系统

Collimation, focusing, motor, all with high efficient, direct full close-loop water cooling system.

技术参数 Technical Data

功率等级 Power Rating	3000W
通光孔径 Clear Aperture	36mm
行程 Travel	
- A轴行程 A-axis	±135°
- C轴行程 C-axis	±540°
- H轴(随动轴)行程 H-Axis	±18.5
保护镜 Cover Glasses	
- 上保护镜 Top	Φ38.1mm×1.6mm
- 下保护镜 Bottom	Φ37mm×7mm
速度 Speed	
- A、C 单轴最大速度 A&C-Single-axis Speed-Max	2rev/s
加速度 Acceleration	
- A、C 轴最大加速度 A&C-axis Acceleration-Max	125rad/s ²
- H 轴(随动轴)最大加速度 H-axis Acceleration-Max	2g

精度 Accuracy	
- A、C 轴分辨率	0.00006°
A&C-axis Resolution	
- A、C 轴定位精度	0.005°
A&C-axis Positioning Accuracy	
- A、C 轴重复定位精度	0.005°
A&C-axis Repeated Positioning	
准直镜焦距 Collimation Length	100mm
聚焦镜焦距 Focusing Length	150mm
光纤接口 Fiber Interface	QBH
重量 Weight	~25.0kg

GF502

龙门AB轴摆动坡口子系统

Gantry AB Axis Wobble Groove Subsystem

功率等级
Power Rating

根据激光头功率
Based on specific power rating of the laser head

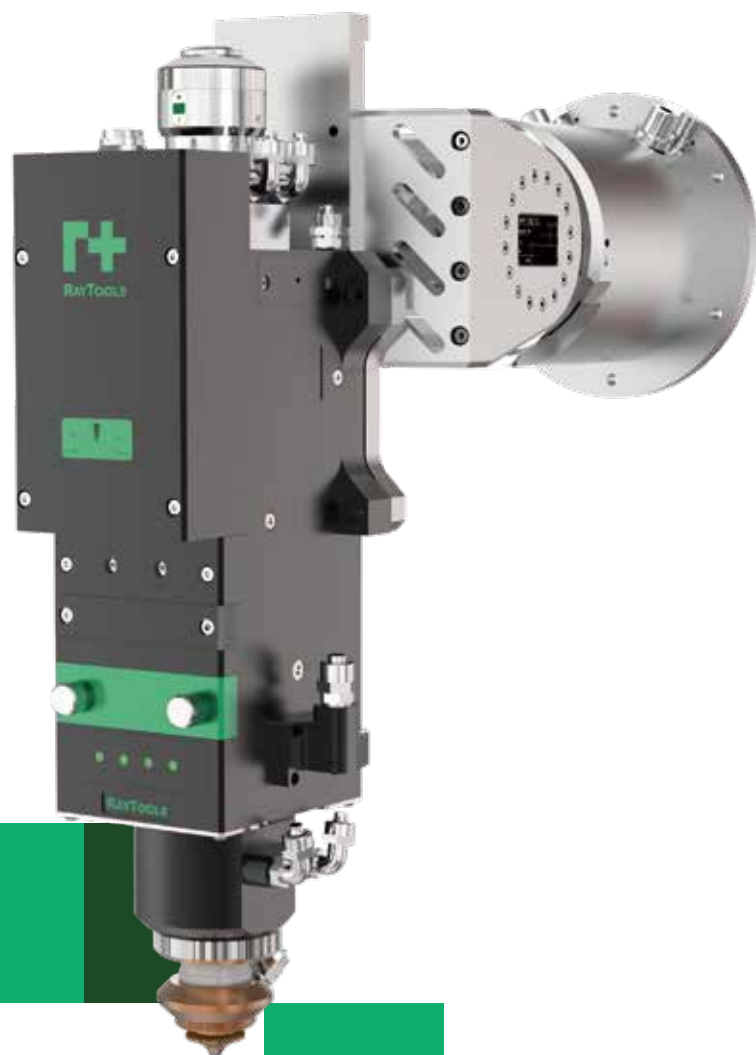

更多信息请扫描二维码
Scan to get details

可沿A、B轴方向旋转, 旋转角度可达±55°

Able to rotate along the A axis & B axis, and the rotation angle can reach ±55°.

结构紧凑, 体积小, 可与机床完美融合

Compact structure with compact size to perfectly integrate with the machine tool.

可搭配不同规格切割头、焊接头、淬火头等, 实现坡口切割、曲面焊接、曲面淬火等

Work with cutting heads, welding heads and quenching heads of different specifications for groove cutting and welding & q-uenching to curved surface, etc.

技术参数 Technical Data

激光头 Laser Head

功率等级 Power Rating	根据激光头功率 Based on specific power rating of the laser head
通光孔径 Clear Aperture	28mm
保护镜片 Cover Glasses	
- 准直保护 Top	Φ24.9mm×1.5mm
- 聚焦保护 Bottom	Φ27.9mm×4.1mm
手动调焦范围 Manual Focus Range	-12mm ~ +10mm
辅助气体气压 Assist Gas Pressure	≤30bar
重量 Weight	~4.5kg

AB轴参数 AB-Axis

单轴摆动范围 Single Axis Bevel Range	±55°
摆动速度 Swing Speed	90r/min
摆动加速度 Swing Acceleration	137rad/s ²
反向间隙 Reverse Clearance	< 0.5arcmin
重量(不含切割头) Weight (Without Cutting Head)	~6.5kg

LaserRobot

非金属三维激光切割解决方案

3D Non-metal Cutting Solutions



GF101 切割系统 GF101 Cutting System

- 内置随动
Built-in follow.
- 方便轻巧
Convenient and light-duty.
- 适用性更广
Wide applications.
- 可选配防撞机构
Optional anti-collision module.

GF102 精密切割子系统 GF102 Micro Cutting Subsystem

- 机器人精密切割
Robotic micro cutting.
- 最小切割直径0.5mm
Minimum cutting diameter 0.5mm.
- 切割精度达0.1mm
Cutting accuracy up to 0.1mm.
- 可选配防撞机构
Optional anti-collision module.



切割端面无毛刺、质量高

Cutting without burr, with high quality.

导光臂内置, 运动范围广

Interior articulated beam delivery arm with a wide range of motion.

高速、高精度、高柔性

High speed, high precision, high flexibility.

灵活生产, 适合非标定制

Customizable with flexible production.

适应多品种, 调试时间短

Applicable to a wide range of materials with fast commissioning.

切割样件 Cutting Samples



车用方向盘
Steering Wheel for Vehicle



汽车保险杠
Car Bumper



汽车仪表盘
Dashboard



汽车顶棚
Car Roof/Ceiling



DynaTools

直线电机切割解决方案

Linear Motor based Cutting Solutions

精度高

High Accuracy

采用精密直线导轨, 定位精度高、磨损少、性能稳定
High precision linear guide with high positioning accuracy, less wearing and stable performance.

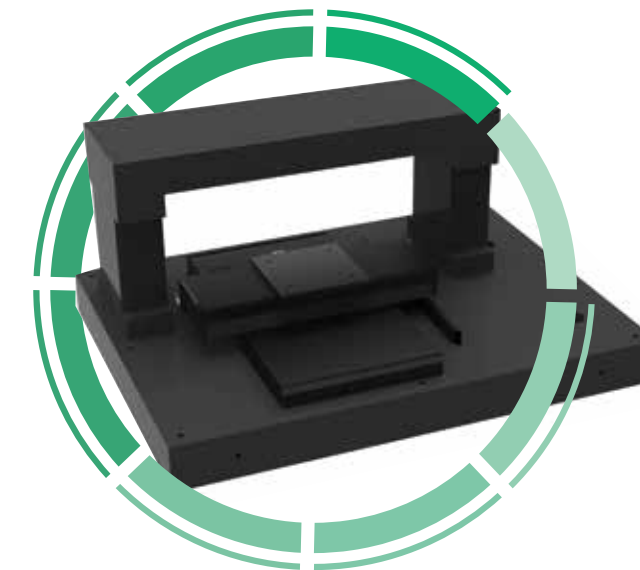
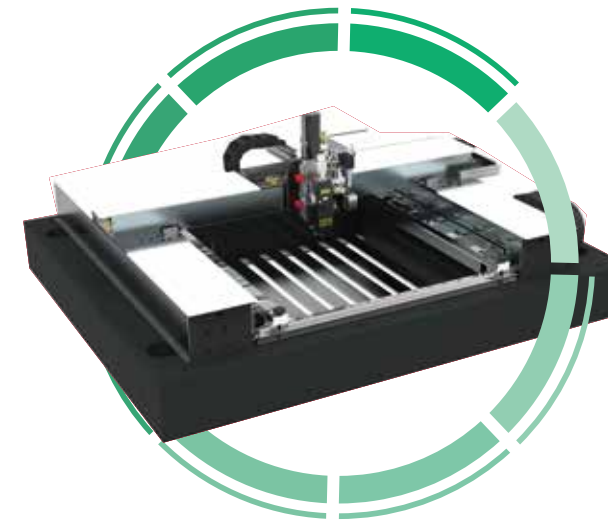
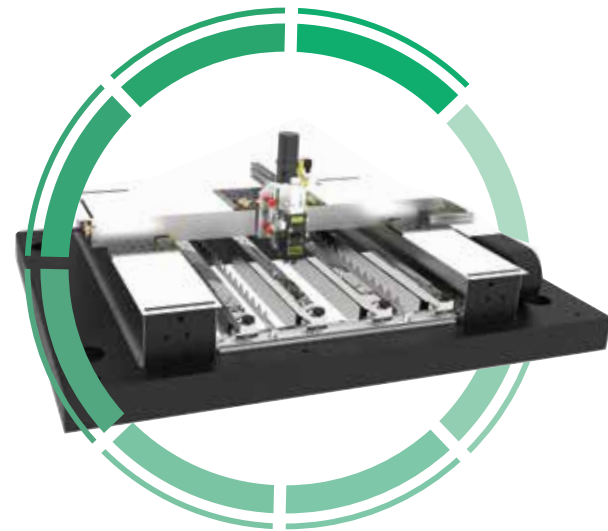
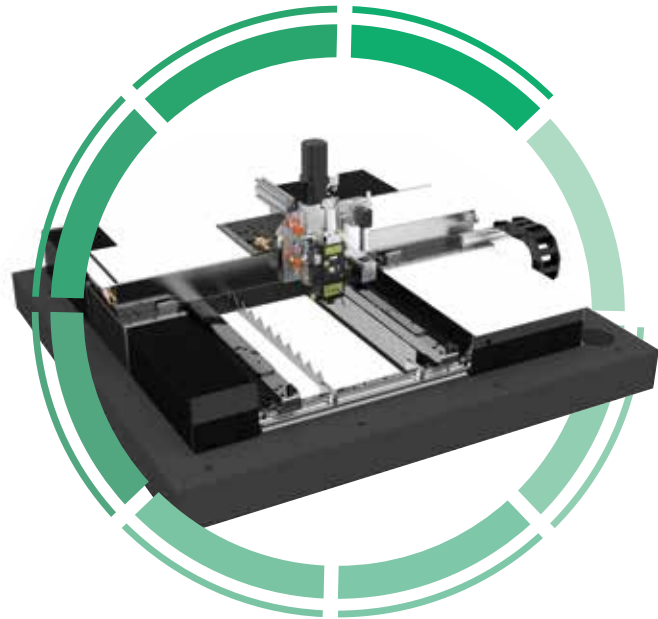

总线数控系统

Busfield Control System

美国AheadTechs激光切割专用系统, 全中文菜单, 操作便捷, 设备灵活性高, 可扩展性大
Laser cutting specialized bus control system from AheadTechs of America, with Chinese menu, convenient operation, high flexibility and expansibility.

应用领域广泛

Wide Range of Applications

可适用于碳钢、不锈钢、铝、铜等各类金属, 同样适用于皮革、陶瓷、玻璃等非金属激光切割以及皮秒、陶瓷、玻璃加工, 超精密切割应用

Applicable to the cutting of a variety of metals, including carbon steel, stainless steel, aluminium, copper, non-metals as leather, ceramic and glass, and the micromachining like picosecond, ceramic processing and glass processing.

优质切割

High Quality Cutting

采用瑞士RayTools激光切割头, 搭配ECAT调高器, 切割速度快、质量高
Laser cutting head of RayTools from Switzerland and ECAT height controller enable the cutting speed fast and quality high.

切割样件 Cutting Samples



工艺品
Precision Cutting

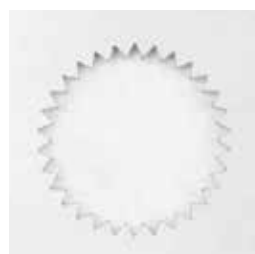

工艺品切割细节
Precision Cutting Details

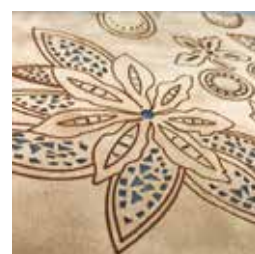

皮革
Leather



皮革切割细节
Leather Cutting Details



眼镜架
Glasses Frame



不锈钢切割细节
Stainless Steel Cutting Details

导光臂 Articulated Beam Delivery Arm



型号 Model	ARM100	ARM200
激光波长 Laser Wavelength	10.6nm、532nm、1064nm	10.6nm
通光孔径 Clear Aperture	15mm	35mm
反射镜 Reflector Mirror	1.0"	2.0"(water-cooled)
功率 Power Rating	0-500W	0-6000W
运动范围 Motion Range		
- 反射镜关节数量 Joints of the Reflectors	7	6
- 旋转自由度数量 Free Rotation Angles	8	7
焦点精度 Focus Accuracy	±0.15mm	±0.06mm
臂长 Arm Length	<2m	<4m
应用推荐 Application Recommended	医疗美容 Medical Aesthetic 手持焊接 Handheld Welding	激光切割、焊接、清洗 Laser Cutting, Welding, Cleaning, etc.



手持方案
Handheld Solution



导光臂悬吊方案
Ceiling-mounted Beam Delivery Solution



机器人导光臂一体机
All-in-one Machine of
Robot & Light Guiding Arm

穿孔检测 BI 300

Pierce Detect

实时的穿孔检测和切割过程监测

Real-time piercing detection and cutting process monitoring.



具有24V数字和模拟0~10V I/O的工业I/O终端用于自动化线路的集成和激光器的连接

I/O with 24V-digital & 0-10V-analogue; Industrial I/O terminal for the integration of automatic lines and connection of lasers.

具有用于过程设置、可视化软件包

With a software package for process setting and visualization.

技术参数 Technical Data

光谱范围 Spectral Range	0.2-1.6μm
采样频率 Sampling Frequency	10kHz (0.1ms)
环境温度 Operating Temperature	-20°C-60°C
外形尺寸 Size	108mm×63mm×56mm
重量 Weight	0.2kg